

INSTRUCTION MANUAL

FIT DISPLAY COMPACT + FIT REMOTE BASIC/E-SHIFT PINION

500085 | 500092 | 501262 | 500429

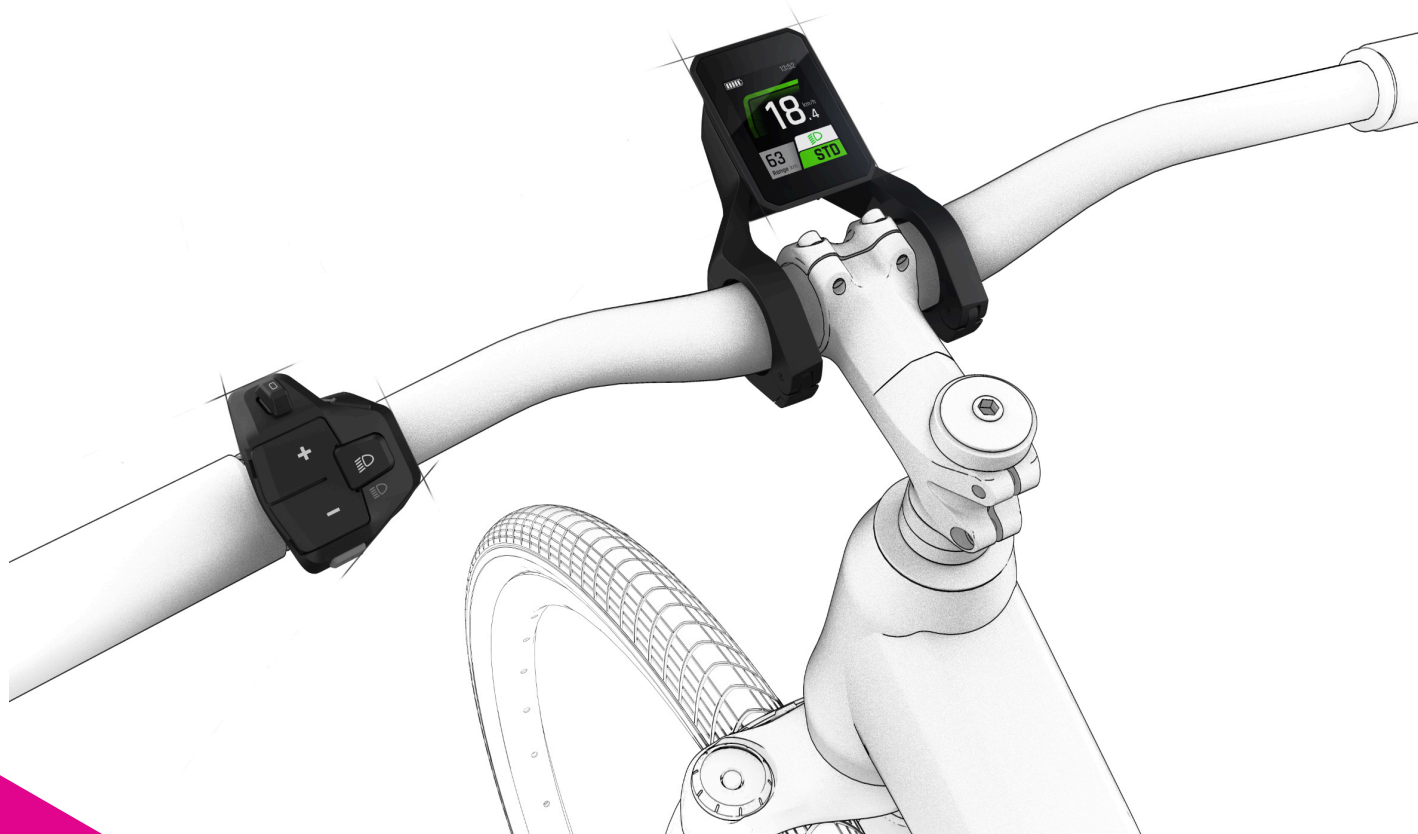

NETWORKED
CUSTOMISED
INTELLIGENT

TABLE OF CONTENTS

1	PREFACE	4
2	ABOUT THESE OPERATING INSTRUCTIONS	5
2.1	MANUFACTURER	5
2.2	LANGUAGE	5
2.3	DECLARATION OF CONFORMITY	5
2.4	ON INFORMATION	5
2.5	WARNINGS IN THESE OPERATING INSTRUCTIONS	5
3	SAFETY INSTRUCTIONS	6
3.1	GENERAL INFORMATION	6
3.2	OPERATING ELEMENT AND DISPLAY	6
4	PRODUCT AND TECHNICAL SPECIFICATIONS	7
4.1	FIT DISPLAY COMPACT	7
4.1.1	DISPLAY AND SETTINGS	7
4.2	OPERATING ELEMENT	8
4.2.1	FIT REMOTE BASIC	8
4.2.2	FIT REMOTE E-SHIFT	9
4.2.3	PINION TE1 E-TRIGGER	10
4.3	PROPER USE	11
4.4	IMPROPER USE	11
4.5	TECHNICAL DATA	11
4.5.1	FIT DISPLAY COMPACT	11
4.5.2	FIT REMOTE BASIC	11
4.5.3	FIT REMOTE E-SHIFT	11
5	TRANSPORTATION AND STORAGE	12
5.1	TRANSPORTATION	12
5.1.1	TRANSPORTING E-BIKES	12
5.2	STORAGE	12
5.3	BREAK IN OPERATION	12
5.3.1	CARRYING OUT A BREAK IN OPERATION	12
6	FITTING	13
6.1	FITTING THE FIT DISPLAY COMPACT	13
7	OPERATION	15
7.1	INITIAL OPERATION	15
7.1.1	ELECTRIC DRIVE SYSTEM	15
7.1.2	PAIRING/COUPLING THE FIT KEY CARD WITH THE FIT E-BIKE CONTROL APP	15
7.2	ASSISTANCE MODES	16
7.2.1	TRAILING	17
7.2.2	PUSHING AID	17
7.2.3	BOOST FUNCTION	17
7.3	LIGHTING	18
7.4	E-SHIFT	19
7.5	NOTIFICATIONS/ERROR MESSAGES	20
7.5.1	WARNING/ERROR SYMBOLS	21
7.6	MAIN/SUB-SCREENS	22
7.6.1	NAVIGATION	25
7.7	CHARGE INDICATOR	29
8	SETTINGS MENU	31
8.1	FIT DISPLAY COMPACT	31
8.2	MENU STRUCTURE	32
8.3	SETTING OPTIONS	33
8.4	E-SHIFT SETTINGS	37
8.4.1	PINION MGU/E-SHIFT	37

9	ERROR MESSAGES	41
9.1	GENERAL INFORMATION	41
9.2	STATUS LED ON OPERATING ELEMENT AND DISPLAY	41
9.3	INFORMATION/ERROR DISPLAY	41
9.3.1	ERROR TABLE	43
10	CLEANING AND SERVICING	59
10.1	BASIC CLEANING	59
10.1.1	CLEANING THE DISPLAY AND OPERATING ELEMENT	59
11	TROUBLESHOOTING, FAULT CLEARANCE AND REPAIR	60
11.1	TROUBLESHOOTING AND FAULT CLEARANCE	60
11.1.1	DRIVE SYSTEM OR DISPLAY DOES NOT START UP	60
11.1.2	ERRORS IN THE ASSISTANCE SYSTEM	60
11.2	REPAIR	61
11.2.1	ORIGINAL PART	61
11.2.2	REPLACING THE LIGHTS	61
11.2.3	ADJUSTING THE HEADLIGHT	61
12	RECYCLING AND DISPOSAL	62
12.1	DISPOSAL	62

1 PREFACE

Dear FIT customer,

The FIT system offers many useful functions and options and we are pleased that you have decided to choose our system.

Please read through the operating instructions carefully to ensure you use the system safely and get off to a quick start.

We hope you enjoy discovering the FIT's functions and have a fun ride every time you use it.

Thank you for placing your trust in FIT.

Your FIT Team

2 ABOUT THESE OPERATING INSTRUCTIONS

2.1 MANUFACTURER

Biketec GmbH
Luzernstrasse 84
CH-4950 Huttwil
fit-ebike.com/en-en/

2.2 LANGUAGE

The original operating instructions are written in German. A translation is invalid without the original operating instructions.

2.3 DECLARATION OF CONFORMITY

Biketec GmbH hereby declares that the products described in these operating instructions comply with EU directives. The complete EU Declaration of Conformity is available online at: fit-ebike.com/en-en/service/declaration/

2.4 ON INFORMATION

Different markings are used in the operating instructions to make them easier to read.

2.5 WARNINGS IN THESE OPERATING INSTRUCTIONS

Warnings indicate hazardous situations and actions. You will find the following warnings in the operating instructions:

**DANGER**

May lead to serious or even fatal injuries if ignored. Medium-risk hazard.

**CAUTION**

May lead to minor or moderate injuries if ignored. Low-risk hazard.

**NOTICE**

May lead to material damage if ignored.

3 SAFETY INSTRUCTIONS

3.1 GENERAL INFORMATION

Please read all safety instructions carefully. Failure to comply with the warnings or take residual risks into account may result in electric shock, fire and/or serious injury.

Keep the operating instructions in a safe place and have them readily available to consult. Pass these instructions on if you provide your e-bike for someone else's use.

The generic names used in these operating instructions, such as motor, battery and operating element, all refer to original FIT e-bike components.

3.2 OPERATING ELEMENT AND DISPLAY

Do not let the messages on the display screen distract you. If you do not focus solely on traffic on the road, you risk being involved in an accident.

Do not open up the operating element or the display. They both can be permanently damaged if they are opened and the warranty will become void.

Do not use the display as a handle. If you use the display to lift your e-bike, you can damage the display irreparably.

Do not place the e-bike upside down on its handlebars and saddle if the display or its mount project above the handlebars. The display or the mount can become irreparably damaged. Also remove the display before placing the e-bike on a work stand to ensure that the display does not fall off or get damaged.

Caution! If you use the operating element with Bluetooth, it may cause interference with other devices and equipment, aircraft, and medical devices, such as pacemakers and hearing aids. Likewise, it cannot be completely ruled out that you will cause harm to people and animals in the immediate vicinity. Avoid operating close to your body for extended periods of time. You must observe local restrictions on using Bluetooth when in aircraft or hospitals, for example, or in close proximity to medical devices, filling stations, chemical plants, blasting zones and areas at risk of explosion.

4 PRODUCT AND TECHNICAL SPECIFICATIONS

4.1 FIT DISPLAY COMPACT

The FIT Display Compact combines the same functions in a compact 2" display as in its larger counterpart, offering optimum visibility in a small design.



4.1.1 DISPLAY AND SETTINGS

The following display elements remain the same on all screens and show the key settings and information about the vehicle and the current trip.

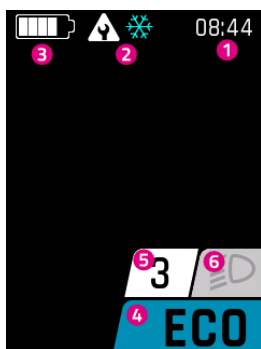





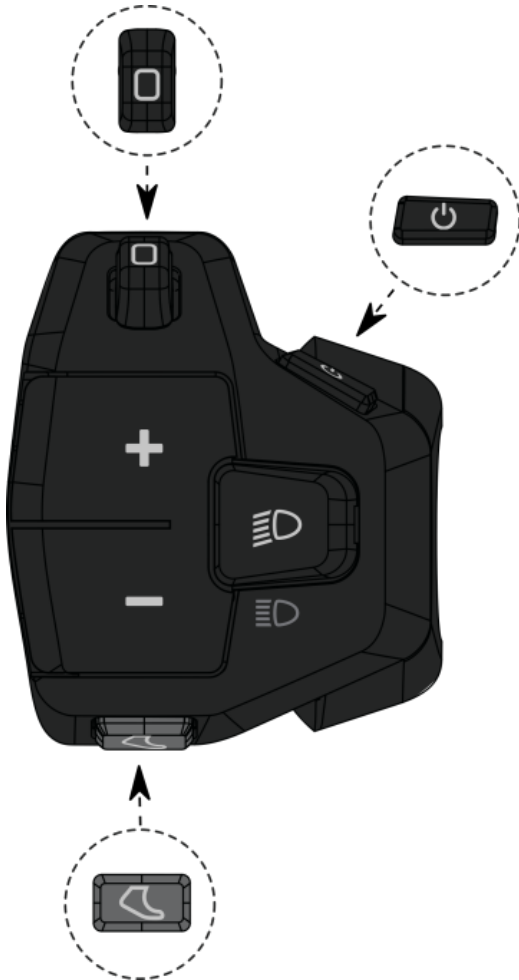

1. Clock
2. Notice/danger alert messages
3. Battery charge level
4. Current level of assistance
5. E-Shift gear indicator
6. Light (main beam/dimmed headlight/off)

4.2 OPERATING ELEMENT

4.2.1 FIT REMOTE BASIC

The ergonomic operating element FIT Remote Basic allows you to control the FIT Display easily and safely, even while riding. The button backlit by LEDs and the vibration feedback ensure optimum usability, even in the dark or while wearing gloves.







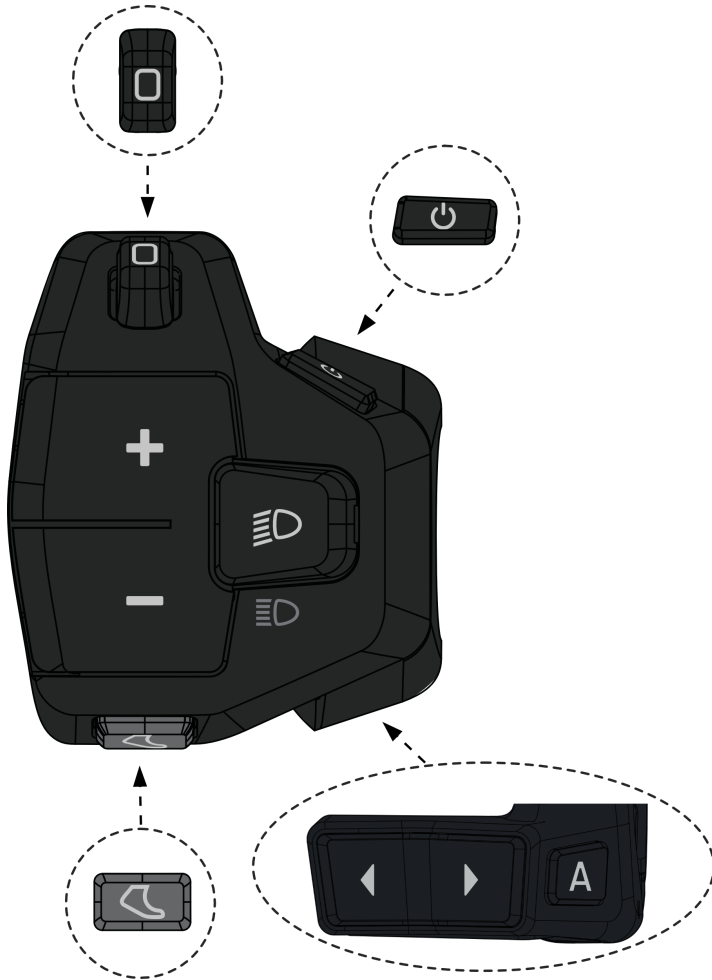

Operating element	Description
	On-off button
	Rocker switch (right, left and press)
	Plus/minus button
	Pushing aid/boost button
	Light button

4.2.2 FIT REMOTE E-SHIFT

The ergonomic FIT Remote E-Shift control unit allows the FIT display to be controlled easily and safely, even while riding. The LED-backlit buttons and vibration feedback guarantee ease of operation even when wearing gloves or in the dark.



Control unit	Description
	On/off button
	Rocker switch (right, left and press)
	Plus/minus button
	Pushing aid/boost button
	Light button
	Gear shift up/down button
	Automatic gear shift button (available soon.)

4.2.3 PINION TE1 E-TRIGGER

The compact Pinion TE1 e-trigger gear lever has been specially developed for shifting with Pinion Smart.Shift shift technology. The goal was to provide clear haptic feedback. With a defined lever path and sophisticated micro button tuning, you can precisely initiate each shifting process. Maintenance-free and waterproof as defined by IP66, the TE1 is the optimal control in every situation.



1. Rear gear lever
2. Front gear lever
3. Matchmaker clamp with screw
4. Blind screw
5. Plug

4.3 PROPER USE

The operating element and the display are designed to control a FIT e-bike system and display trip data.

4.4 IMPROPER USE

Improper use refers to use which is not described under **proper use** or goes beyond **proper use**.

4.5 TECHNICAL DATA

4.5.1 FIT DISPLAY COMPACT

Display		FIT Display Compact
Product code		500085
Operating temperature	°C	-5 to +40
Storage temperature	°C	-10 to +50
Protection class		IPX7
Weight about	kg	0.1

4.5.2 FIT REMOTE BASIC

Operating element		FIT Remote Basic
Product code		500092 (without spacer) 501262 (with spacer)
Operating temperature	°C	-10 to +40
Storage temperature	°C	-20 to +50
Protection class		IPX7
Weight about	kg	0.05

4.5.3 FIT REMOTE E-SHIFT

Operating element		FIT Remote E-Shift
Product code		500429
Operating temperature	°C	-10 to +40
Storage temperature	°C	-20 to +50
Protection class		IPX7
Weight about	kg	0,06

5 TRANSPORTATION AND STORAGE

5.1 TRANSPORTATION

**CAUTION**

- Remove battery before transportation.
- There is a risk of injury if the drive system is switched on unintentionally.

5.1.1 TRANSPORTING E-BIKES

Protect the electrical components and connections on the e-bike from the elements with suitable protective covers.

5.2 STORAGE

**CAUTION**

- Store e-bike, display, battery and charger in a clean, dry place where they are protected from sunlight. Do not store outdoors to ensure a long service life.
- The optimum storage temperature for your e-bike is between 10 °C and 20 °C.
- Temperatures under -10 °C or over +40 °C must generally be avoided.
- Store e-bike, display, battery and charger separately.

5.3 BREAK IN OPERATION

If you remove the e-bike from service for longer than four weeks, you need to prepare it for a break in operation.

5.3.1 CARRYING OUT A BREAK IN OPERATION

Store the e-bike, battery and charger in a dry, clean environment. We recommend storing them in uninhabited rooms with smoke alarms. Dry locations with an ambient temperature between 10 and 20 °C are ideal.

6 FITTING

6.1 FITTING THE FIT DISPLAY COMPACT

As the mount docks available to hold the display are identical, the FIT Universal Mount is used as an example to show how the display is fitted into place. The display is fitted in the same way on the FIT Display Center Mount.

FIT Display Universal Mount



FIT Display Center Mount



Inserting FIT Display Compact

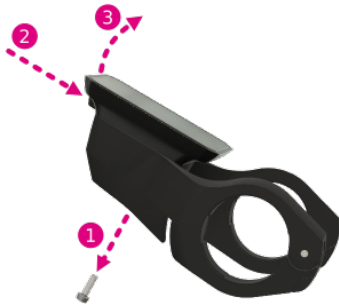

1. Place the lower section of the display into the mount.
2. Gently press the display downwards until you feel it latch into place.
3. Optional: Secure display with anti-theft securing screw.

Removing FIT Display Compact

1. Remove the anti-theft securing screw if you have one fitted.
2. Press the unlocking mechanism.
3. Remove display, pulling it upwards.

7 OPERATION

7.1 INITIAL OPERATION

7.1.1 ELECTRIC DRIVE SYSTEM

SWITCHING ON THE ELECTRIC DRIVE SYSTEM The system can only be switched on if a sufficiently charged battery and the display are inserted.

Press the on-off button for at least one second to switch on the system. The «Drive» menu is shown on the display screen.

SWITCHING OFF THE ELECTRIC DRIVE SYSTEM The drive system switches off automatically to save energy if no rider activity is detected for a longer period of time. (The rider can adjust the time interval until switch-off in the settings menu -> MyBike -> Auto Power Off.) The display is operated using the rocker switch on the operating element so that your hands can remain on the handlebars while you are riding.

Press the on-off button for at least a second to switch off the electric system by hand.

OPERATION You can use the rocker switch to access the different main screens (right/left) and their respective sub-screens (press). The settings menu can only be accessed when the e-bike is stationary. You can use the plus/minus button to select the level of assistance. You can use plus/minus to scroll up and down a list you have accessed, such as the Settings menu. If the light button and the rocker switch (press) have a new function (OK, Back), this is shown on the display.

7.1.2 PAIRING/COUPLING THE FIT KEY CARD WITH THE FIT E-BIKE CONTROL APP

The FIT Key Card is your ticket to the digital FIT world for every e-bike with FIT 2.0 integration. The individual ID is based on the SmartX technology from ABUS and ensures a secure connection to the e-bike with a unique key.



NOTICE

- Keep the card in a safe place as it serves as the e-bike's ID.
- Can be reordered subject to payment in the e-shop if lost.

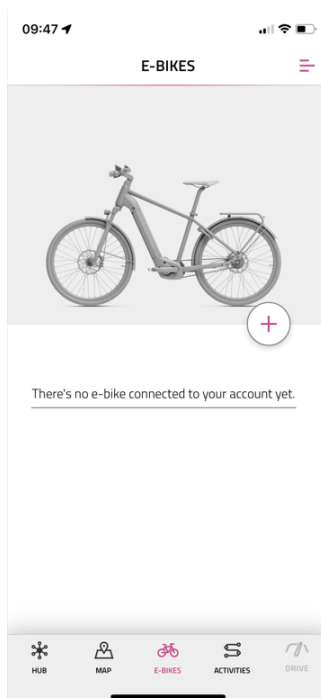

- Select the menu **E-bikes** in the navigation bar
- Press the **+** icon to add your e-bike in the FIT E-Bike Control app

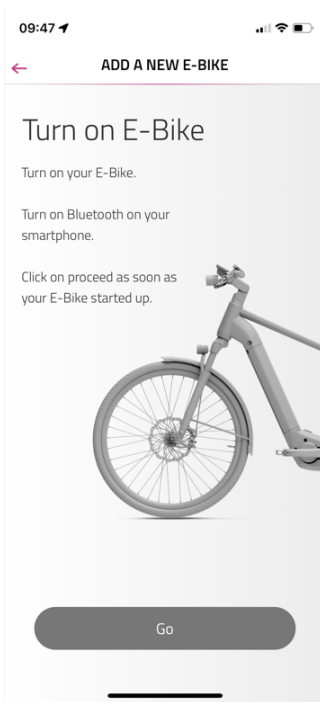

- Follow the instructions in the FIT E-Bike Control app

7.2 ASSISTANCE MODES

You can set the assistance levels using the + and – buttons on the control unit.

Symbol	Description
FLY	Maximum motor assistance for a sporty ride in any situation up to high pedaling frequencies.
FLEX	Variable motor assistance that adapts to your riding performance, covering the entire range for super agile e-biking.
FLOW	Variable motor assistance that adapts to your riding performance for moderate, energy-saving cross-country or off-road trips.
ECO	Minimal motor assistance for maximum efficiency and maximum range.
OFF	No motor assistance. The e-bike rides like a normal bicycle. All on-board computer functions and electric gears are available.

7.2.1 TRAILING

Trailing ensures that the motor assistance remains active for a short time when you stop pedaling. The pre-set trailing makes the power delivery of the Pinion MGU even more harmonious and natural for city and trekking e-bikes, as the lack of force with the vertical pedal position at low cadence is easily overcome. In technically demanding situations and in the event of obstacles on the terrain, the riding pace is noticeably improved with trailing, should you decide to stop pedaling. If you deactivate this feature, the MGU immediately stops the motor assistance once you stop pedaling.



NOTICE

Trailing is activated by default, and can be deactivated only via the FIT E-Bike Control App. To use the FIT E-Bike Control App, your smartphone must be connected to the e-bike using a FIT Key Card (see Section I 7.1.2).

7.2.2 PUSHING AID

Assistance mode icon:



The pushing aid makes it easier to push the e-bike. The e-bike can be moved out of underground parking or along steep paths comfortably by activating the pushing aid.

Briefly press the pushing aid/boost button to activate pushing aid mode. Press again to start the pushing aid.

If you release the pushing aid/boost button for more than five seconds, you will leave pushing aid mode. Pushing aid speed can be adjusted via the settings menu.

While using the pushing aid, the pushing aid speed can be temporarily reduced/increased via the buttons on the TE1 trigger.



CAUTION

When using the pushing aid, the wheels must be in contact with the ground, otherwise there is a risk of injury.

7.2.3 BOOST FUNCTION

Assistance mode icon:





The Boost function can be used to briefly increase motor support to FLY level regardless of the selected assistance level (ECO, FLOW, FLEX). This function can be activated at speeds of 7 km/h and over and if at least one quarter pedal revolution has been detected. The Boost function cannot be used if the pushing aid mode is active.

Press the Pushing aid/Boost button to activate the Boost function. The Boost function is activated as long as the button is held down.

7.3 LIGHTING

You can use the light button to switch between the following lighting modes (availability depends on the model):

Symbol	Description
	Dimmed headlight
	Main beam
	Light off

Different lighting systems are fitted depending on the bike type and field of use. If the system features a daytime running light function, the bike switches between the dimmed and daytime running lights automatically.

The dimmed headlight is permanently activated on S pedelecs because of EU directives. Pressing the light button will activate or deactivate the main beam as well.

7.4 E-SHIFT

Use the up/down buttons on the gear shift to select the gear manually.

You can switch to or exit the automatic mode selected in the settings menu (Auto.Shift or Auto.Shift.Pro) by pressing the automatic gear shift button on the FIT Remote E-Shift or pressing and holding the button (3 seconds) on the front lever of the Pinion TE1 e-trigger.

The gearbox provides assistance with 9-speed and 12-speed. You can shift through multiple gears at once (e.g. from 06 to 02). Changing gears while stationary or when the crank is at rest or rotating backward is possible, and protects the gearbox.

- **Shifting down (12-11-10 ... -01):** Possible to a limited extent under load-bearing. Shifting will not be available if there is too much pressure on the pedal.
- **Shifting up (01-02-03 ... -12):** A mechanism in the gearbox allows you to shift up under load; the pressure needs to be briefly released from the pedal only when changing between the respective sub-gearboxes.
- **For P1.9 motor only:** When shifting up from 03 to 04 and from 06 to 07, always make sure to release any pressure from the pedal.
- **For P1.12 motor only:** When shifting up from 04 to 05 and from 08 to 09, always release pressure from the pedal.



NOTICE

Occasionally, the crank may «drop» after a gear shift by about 10°, causing a brief jerk until the shifter pawl engages in the next tooth. This is normal and does not damage the gearbox.

Symbol	Beschreibung
	Current selected speed
	Auto.Shift active
	Auto.Shift.Pro active
	Gear recommendation – change up a gear
	Gear recommendation – change down a gear

AUTO.SHIFT

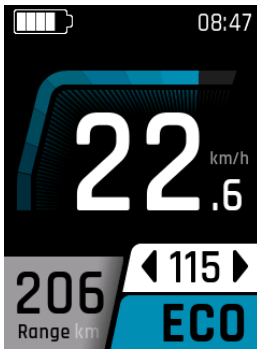

- In Auto.Shift mode, the up/down button (e.g. Pinion TE1 E-Trigger or FIT Remote E-Shift) is used to reduce/increase the cadence (pedal frequency).
- If the cadence is changed, the cadence display will be shown briefly.

AUTO.SHIFT.PRO

Auto.Shift.Pro is designed for sporty, dynamic riding and automatically changes to the gear that matches your cadence (pedaling frequency) defined in the settings menu. In contrast to Auto.Shift mode, with Auto.Shift.Pro you use the control unit (e.g. Pinion TE1 E-Trigger or FIT Remote E-Shift) not only to adjust the cadence, but also to override automatic mode and manually set the desired speed in every situation.

If you change gear manually in Auto.Shift.Pro mode, the system registers your current cadence and adjusts the automatic gear shifting according to your preference.

If you want to return to the original cadence (the number in the settings menu) while riding, you can do this by pressing and holding the button (3 seconds) on the rear lever of the Pinion TE1 E-Trigger.



NOTICE

Switching to the original cadence setting is possible only with the Pinion TE1 E-Trigger, and not with the FIT Remote E-Shift.

7.5 NOTIFICATIONS/ERROR MESSAGES

When they occur, notifications and error messages are displayed with a frame across the entire width of the display so that they are not overlooked. If several messages occur at the same time, the display shows nested frames to show all relevant information.

You can acknowledge the messages by pressing the rocker switch. If the underlying problem has not been solved, a corresponding icon appears in the top right-hand corner of the display. If several messages appear at the same time, the next message is displayed after acknowledging the first message until all have been acknowledged. This allows you to process all messages that occur systematically. See the 9.3.1 chapter for more information.

For better illustration, you will find sample images below with a single message and several messages as well as a list of the icons used.

INDIVIDUAL NOTICE/ERROR MESSAGE

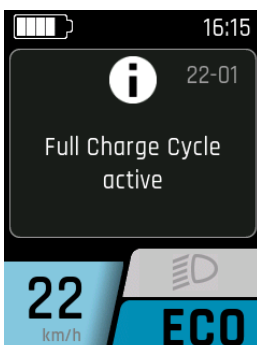

- The display shows a single error message across the entire width of the display. The frame around the press release emphasizes them and makes them clearly visible.
- You can acknowledge the message by pressing the rocker switch.

SEVERAL NOTIFICATIONS/ERROR MESSAGES

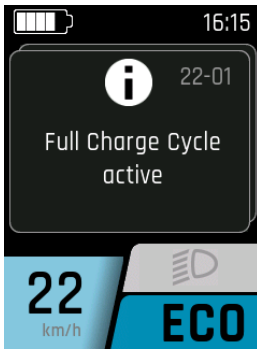

- The display shows several error messages which are shown in nested frames. This provides a clear overview of all messages occurring simultaneously.
- You can edit the messages one after the other by acknowledging the messages with the selection rocker switch. After acknowledging a message, the next message appears until all have been processed.

7.5.1 WARNING/ERROR SYMBOLS

Symbol	Meaning	Action/Limitation
	Ice hazard (temperature ≤ 4 °C)	Drive carefully.
	Maintenance request	Your e-bike should be taken to the FIT specialist dealer for maintenance as soon as possible.
	Motor overheat	Reduced ride assistance performance. (This is not an error, but is meant to protect the motor.)
	Battery protection mode (battery level and/or temperature too low)	Reduced ride assistance performance. (This is not an error, but is meant to protect the battery.)
	Low tire pressure	Check and adjust the tire pressure if necessary. (This function is only available with optional tire pressure sensors.)
	Limiting the assistance speed	The motor assistance is only active until the limit set in the settings menu is reached.
	Info	Motor assistance available The message can be acknowledged by pressing the rocker switch. (For more information, see section 9.3.1)
	Warning	Motor assistance available The message can be acknowledged by pressing the rocker switch. (For more information, see section 9.3.1)
	Error/Critical error	No motor assistance Motor assistance is only available once the error has been rectified and the system has been restarted (only in the case of a critical error). (For more information, see section 9.3.1)

7.6 MAIN/SUB-SCREENS

MAIN DRIVE SCREEN

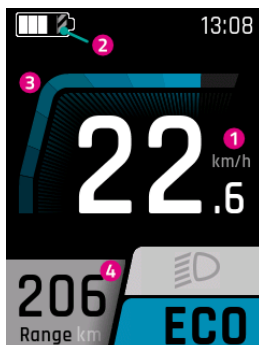

1. Current speed
2. The hatched part indicates that the battery is in Long Life mode. If Long Life mode is deactivated, the hatching disappears. (For more information, see section 7.7)
3. Current motor assistance
4. Range (in current assistance setting/level of assistance)

DRIVE SUB-SCREEN

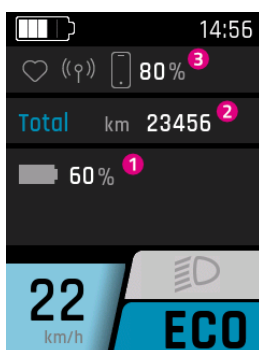

1. Battery charge level (if there is more than one battery, they are all displayed and are numbered consecutively)
2. Odometer (total number of kilometers that the e-bike has covered. This value cannot be reset)
3. Linked devices (heart rate sensor, smartphone, including smartphone battery charge level)

DRIVE SUB-SCREEN 2 (only available with installed FIT tire pressure sensors)

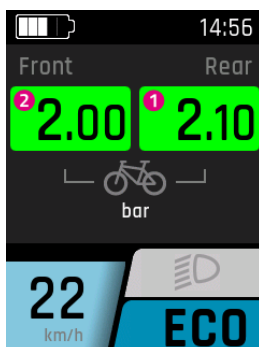

1. Current rear tire pressure
2. Current front tire pressure

TRIP MAIN SCREEN



1. Distance ridden during the current trip
2. Duration of the current trip

TRIP SUB-SCREEN

1. Difference in altitude ridden during the current trip
2. Average battery consumption during the current trip

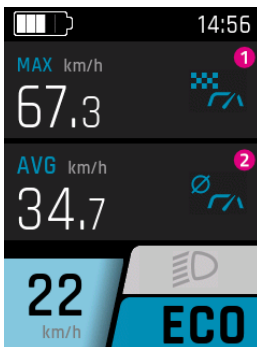
TRIP SUB-SCREEN 2

1. Maximum speed for the current trip
2. Average speed of the current trip

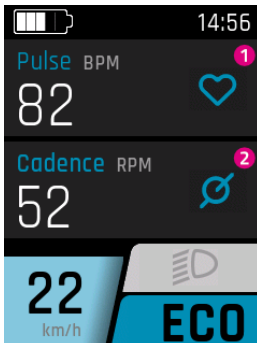
FITNESS MAIN SCREEN

1. Current pulse (only displayed if a heart rate sensor is connected. This option depends on the model. The system only supports heart rate bracelets featuring Bluetooth 4 and higher or Bluetooth Low Energy.)
2. Current pedal speed

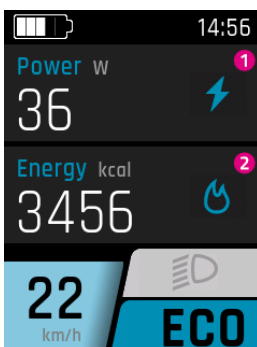
FITNESS SUB-SCREEN

1. The rider's current pedalling power
2. Calorie consumption during the current trip

AREA MAIN SCREEN

1. Current altitude (measured based on the air pressure)
2. Current ascent or descent as a percentage

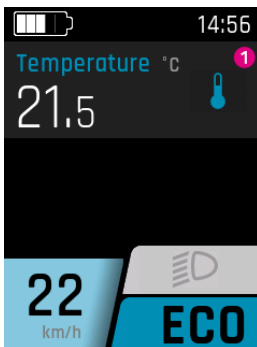
AREA SUB-SCREEN

1. Current temperature

AREA SUB-DISPLAY

The weather forecast is only available in conjunction with the FIT E-Bike Control app. To use the FIT E-Bike Control app, the smartphone must be connected to the e-bike using the FIT Key Card (see Section 7.1.2).

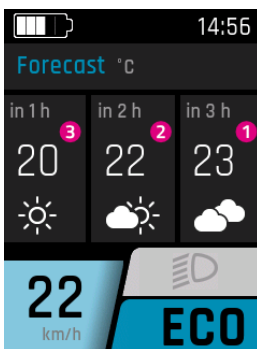

1. Weather forecast in three hours
2. Weather forecast in two hours
3. Weather forecast in one hour

7.6.1 NAVIGATION

Navigation is only available in conjunction with the FIT E-Bike Control app. To use the FIT E-Bike Control app, the smartphone must be connected to the e-bike using the FIT Key Card (see section 7.1.2).



There are two types of navigation available:

- **MAP:** Direct destination entry and navigation in the FIT E-Bike Control app.
- **ACTIVITIES:** Tour records and planned tours of the connected komoot account can be displayed here. Navigation is available on all routes under Planned Tours.



NOTICE

To use the navigation function, you must observe the following points:

- The e-bike must be switched on and connected to the smartphone.
- To ensure the connection (Bluetooth) between the e-bike and the FIT E-Bike Control app, the smartphone and e-bike must be no more than five meters apart.
- The e-bike must be linked to the FIT E-Bike Control app (see section 7.1.2).

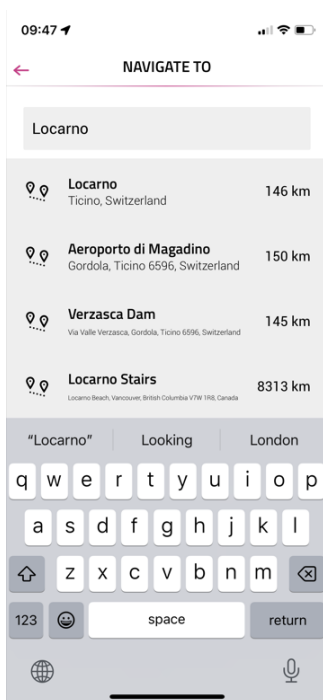

Navigate to:

- Enter the desired navigation destination.

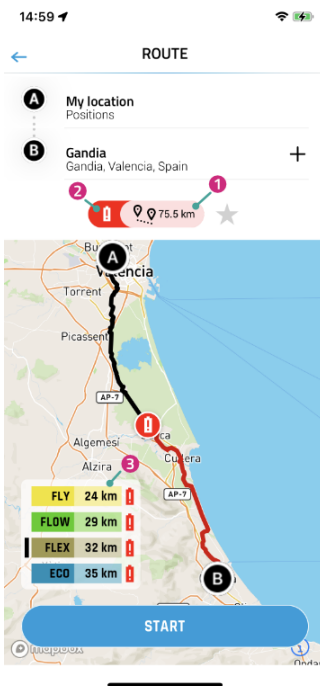

After entering the start and end point, information about the selected route is displayed:

1. Distance to the target.
2. The red battery symbol indicates that the current charging status is not sufficient to reach the destination in any assistance level.
3. Current range in the various assistance levels (the black bar shows the assistance level currently selected on the e-bike).

Navigation can be started with **START**.

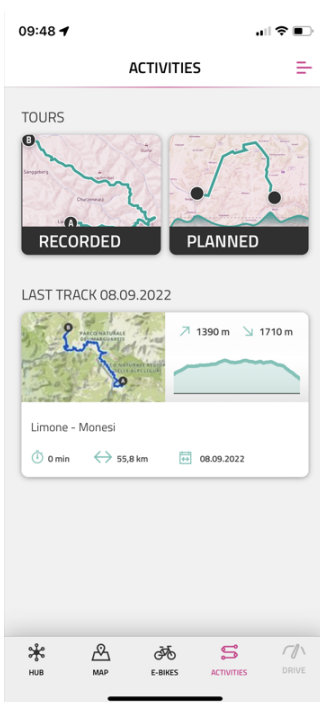

In the ACTIVITIES menu, you can choose between recorded and planned tours from the linked komoot account. The last route is also available as a speed dial.



NOTICE

After linking your komoot account for the first time, it will take a while for all planned tours to be synchronized.

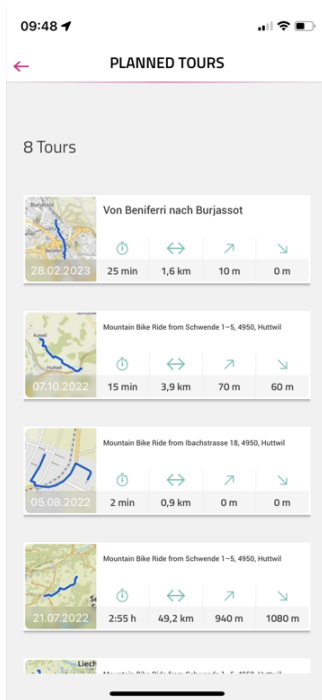

The PLANNED TOURS menu displays the planned tours of the linked komoot account with information on duration, route length, highest and lowest points. Here you can select a tour for navigation.

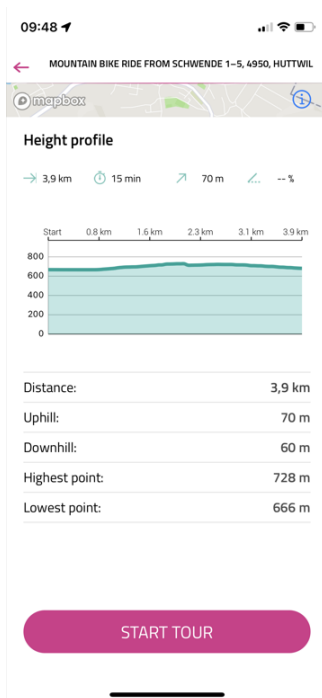

After selecting a tour, the details of the tour are displayed again in detail. Navigation can be started using **START TOUR**.

NAVI MAIN DISPLAY

If navigation on the smartphone has not been started, the following message appears.

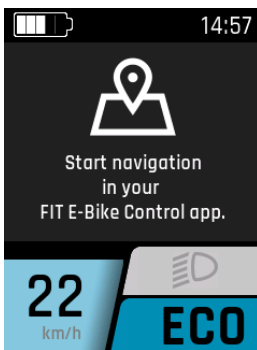

If navigation has been started on the smartphone, the following display appears.

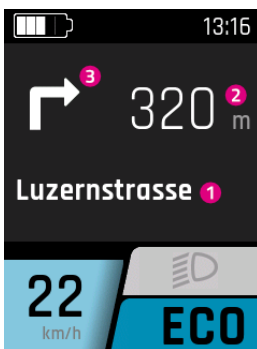

1. The distance to the next navigation point
2. Road ahead
3. Navigation direction at next navigation point

From 100m before a navigation point, the distance is also indicated by a bar.

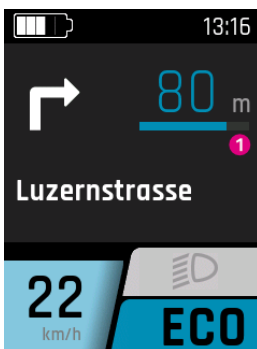

1. The distance to the next navigation point

NAVI SUB-DISPLAY

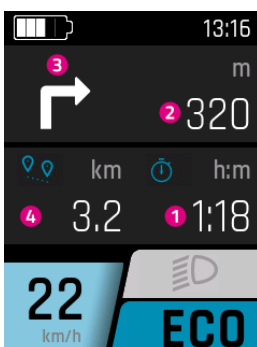

1. Current remaining time to the navigation destination
2. The distance to the next navigation point
3. Navigation direction at next navigation point
4. Current remaining distance to the navigation destination

DISPLAY CALLS

The call display is only available in conjunction with the FIT E-Bike Control app. To use the FIT E-Bike Control app, the smartphone must be connected to the e-bike using the FIT Key Card (see section 7.1.2).



CAUTION

Do not take calls while riding.

When a call is displayed, first find a suitable place to stop before answering the call.

To enable the call to be displayed, the necessary authorizations must be granted to the FIT E-Bike Control app once on the smartphone. In the E-bike Settings menu, the call display must be activated in the **Connectivity** submenu.

The calls are only displayed. Calls cannot be accepted via FIT Remote.



NOTICE

- Android – Only phone calls are displayed.
- iOS – Displays phone calls and messenger calls.

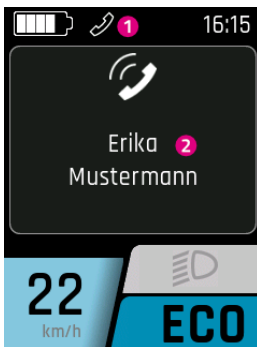

1. Incoming call icon.

If the call display is acknowledged by pressing the select rocker switch, the caller's name disappears. The icon remains as long as the smartphone displays an incoming call.

2. Name of the caller (taken over by the connected smartphone).

Only the most common special characters can be displayed. Unrepresentable characters and emoticons are replaced by a question mark (?) on the display.

7.7 CHARGE INDICATOR

Menu – Charge

The charge indicator appears as soon as the charger is connected to the e-bike. Use the plus/minus button to select the charging mode (NORM, FAST, STORE) and save it by pressing the rocker switch. The Long Life mode can be switched on or off with the light button.

Charging mode	Description
NORM (Normal)	Normal charging
FAST (Fast)	Fast charging
STORE (Storage)	Storage mode If the battery is not going to be used for an extended period of time, we recommend storage mode «Storage» and an optimum storage temperature between 5 and 15°C. In Storage mode, the battery is charged to about 60% which allows the battery to bridge the time until it is reused as gently as possible.
Long Life	Slightly less capacity is available if the battery is used in LONG LIFE mode. On the other hand, the battery retains its capacity for longer. The LONG LIFE mode is available for both normal and fast charging. In LONG LIFE mode, the battery is charged to about 80%.

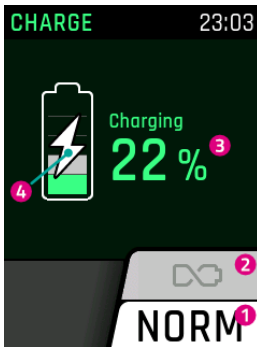
NORMAL CHARGING OF SINGLE BATTERY

1. Current charging mode
2. Long Life mode (grayed out = switched off)
3. Current battery charge level
4. Shows battery is currently being charged

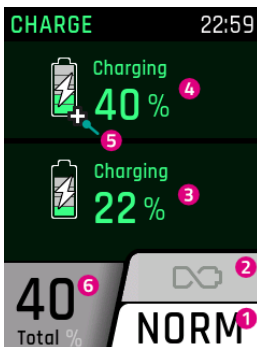
NORMAL CHARGING OF MULTIPLE BATTERIES

1. Current charging mode
2. Long Life mode (grayed out = switched off)
3. Current charge level of the second battery
4. Current charge level of the first battery
5. Range Extenders are displayed with a plus sign
6. Charging status based on the total capacity of the batteries on the e-bike

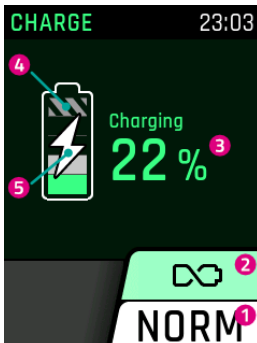
LONG LIFE MODE CHARGING

1. Current charging mode
2. Long Life mode (green background = switched on)
3. Current battery charge level
4. As the battery is not fully charged in Long Life mode, the rest is gray-hatched
5. Shows battery is currently being charged

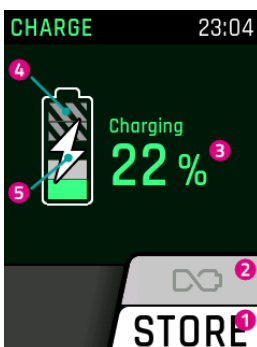
CHARGING IN STORAGE MODE

1. Current charging mode
2. Long Life mode (grayed out = switched off)
3. Current battery charge level
4. As the battery is not fully charged in storage mode, the rest is gray-hatched
5. Shows battery is currently being charged

8 SETTINGS MENU

The settings menu is the last screen, which can be accessed by pressing the rocker switch to the right. It can only be accessed when the e-bike is stationary.

8.1 FIT DISPLAY COMPACT

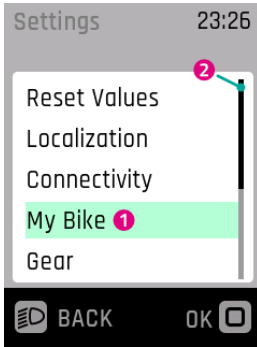

- 1. Currently selected sub-menu
- 2. Scroll bar

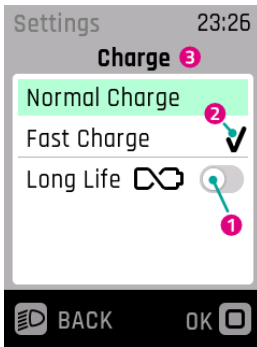

- 1. Option disabled (left slide switch and grayed out)
- 2. Currently selected setting
- 3. Current sub-menu

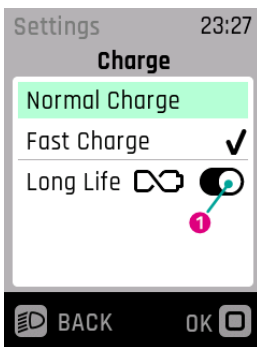

- 1. Option enabled (slide switch on the right and black)

8.2 MENU STRUCTURE

1. Reset Values
 - (a) Trip Reset
 - i. Manually Reset
 - ii. Auto Reset
 - (b) Factory Reset
2. Localization
 - (a) Language
 - (b) Date and time
 - i. Time
 - ii. Time zone (only after activation by the specialist dealer. Coming soon.)
 - iii. Automatic time change (only after having been enabled by the specialist dealer. Coming soon.)
 - iv. Set time automatically (only after having been enabled by the specialist dealer. Coming soon.)
 - v. Time Format
 - vi. Date
 - (c) Units (metric/imperial)
3. Connectivity
 - (a) Connect Heart Rate Sensor
 - (b) Disconnect Heart Rate Sensor
 - (c) Display calls
4. My Bike
 - (a) Calibrate Altitude
 - (b) Auto Backlight
 - (c) Auto Power Off
 - (d) Vibration Feedback
 - (e) Motor cut-off during braking (S-Pedelec only)
 - (f) Disable Menu Overlay (FIT Remote Display only)
 - (g) Limit assist speed
5. Gear
 - (a) Gear trigger assignment
 - i. Standard
 - ii. Inverse
 - (b) Smart.Shift
 - i. Start.Select
 - ii. Pre.Select
 - iii. Auto.Shift
 - A. Auto.Shift.Pro
 - B. Startng gear
 - (c) Calibration
6. Charging
 - (a) Normal Charge
 - (b) Fast Charge
 - (c) Long Life Mode
7. Tire pressure (only available with tire pressure sensors)
 - (a) Pressure Unit
 - (b) Front
 - (c) Rear
8. Errors
9. About

8.3 SETTING OPTIONS

Menu – Reset values

The tour data and the system can be reset to the factory settings in this menu.

Trip Reset

Resets the trip data. You can choose between resetting manually (one-time) or resetting automatically according to the following criteria:

Selection	Description
Off	Automatic reset disabled
After rebooting	Reset automatically when the e-bike is switched off and on again
After 4 hours of inactivity	Reset automatically when the e-bike is switched off for more than 4 hours
Once a day	The tour dates are reset once a day (at 0h00)

Factory Reset

Returns the system to its default state. All settings and saved values are deleted. The deletion cannot be undone.

Menu – Basic settings

The basic display settings can be carried out in this menu.

Language

Select the display language.

Date and time

In the Date and time menu, you can configure all the settings for the date and time.

Time

You can set the current time in the time menu. The current digit can be changed by pressing the plus/minus button. Select the number to be changed with the selection rocker switch. Press the selection rocker switch to save the time and quit the time menu. Press "Cancel" to leave the menu without saving the changes.

Time zone (only after having been enabled by the specialist dealer. Coming soon.)

Setting the current time zone.

Automatic time change (only after having been enabled by the specialist dealer. Coming soon.)

If the Automatic daylight saving time setting is activated, the time is automatically changed between summer and winter time.

Set time automatically (only after having been enabled by the specialist dealer. Coming soon.)

If Set time automatically is enabled, the time and date (UTC) are adopted from the connected mobile phone or installed FIT E-Bike Tracker.

The time and date can no longer be set manually on the e-bike if the automatic time setting is enabled.

The time zone, automatic daylight saving time and time format can still be set on the e-bike. This means that a different time zone can be displayed on the e-bike, regardless of the mobile phone setting.

Time format

Toggle the time display between 12h and 24h.

Date

You can set the current date in the date menu. The current digit can be changed by pressing the plus/minus button. Select the number to be changed with the selection rocker switch. Press the selection rocker switch to save the date and quit the menu. Press "Cancel" to leave the menu without saving the changes.

Units

You can switch between the metric and imperial system in the units menu. The following units are replaced:

Measured value	Metric	Imperial
Distance	km	mi
Speed	km/h	mph
Energy consumption	Wh/km	Wh/mi
Temperature	°C	°F
Elevation	m.a.s.l.	FAMSL

Menu – Connectivity

In this menu, you can manage various connections and settings relating to the connectivity of your e-bike.

Connect heart rate monitor

Connect your heart rate monitor to your e-bike to keep an eye on your heart rate directly on the display while riding.

Disconnect heart rate monitor

Disconnect your heart rate monitor if you no longer want to use it with your e-bike.

Display calls

Decide whether incoming calls from your connected smartphone should be shown on the e-bike display so that you don't miss any important calls or get distracted while riding.

Menu – My Bike

The user-related settings for the e-bike can be carried out in this menu.

Calibrate Altitude

The altimeter is calibrated in the calibration menu.

Important: The altitude measurement depends on the atmospheric pressure and can lead to deviations if this changes. We recommend that you carry out a calibration if the weather changes.

Auto Backlight

You can choose between the automatic adjustment of the display's backlighting to the ambient light (ON) or a manual setting of the backlighting (OFF) between 10 and 100% in this menu. Pressing the selection rocker switch saves the selected backlight and exits the menu. Clicking Cancel exits the menu without saving any changes.

**NOTICE**

- If the Display gets too hot, the backlighting is automatically reduced to 20%. This is a precautionary measure to prevent temporary discoloration on the display.
- When the temperature has fallen back to normal, the brightness automatically switches back to the previously set value.

Auto Power Off

The Power off menu can be used to set the time after which the system switches off automatically when not in use.

Vibration feedback

The vibration can be set as feedback from the control unit in the vibration feedback menu. The following setting options are available:

Selection	Description
Off	No vibration feedback
On	Every button press/active message generates vibration feedback
Only for messages	Vibration feedback is only generated for messages

Motor cut-off during braking (S-Pedelec only)

In the menu Motor cut-off during braking, you can choose whether or not motor assistance should switch off automatically during braking. This function is only available for S-Pedelecs.

Disable Menu Overlay (FIT Remote Display only)

In the Disable menu display menu, you can select whether, during the trip, the selection display appears while switching between the main displays or whether you want to switch directly between the main displays. This function is only available with the Remote display.

Limit assist speed

In the Assistance speed limitation menu, you can set the speed up to which the motor assistance should be active.

Menu – Charging

The desired charging mode as well as the LONG LIFE mode for the battery can be set in the Charge menu.

Charging mode	Description
Normal Charge	Normal charging
Fast Charge	Fast charging
Long Life Mode	If the battery is used in Long Life Mode, there is slightly less capacity available. On the other hand, the battery retains its capacity for longer. The Long Life Mode is available for both normal and fast charging.

Menu – Tyre pressure (available if tyre pressure sensors are installed)

In this menu, you can adjust the settings for your tyre pressure sensors.

Pressure unit

Change the pressure unit to bar or psi as required.

Front

Set the minimum and normal pressure for the front tyre.

The current pressure is displayed as a number and in a bar graph to provide you with optimum support when inflating your tyres.

Rear

Set the minimum and normal pressure for the rear tyre.

The current pressure is displayed as a number and in a bar graph to help you achieve exactly the right pressure when inflating.

Menu – Errors

The list of current error messages can be viewed in the messages menu.

Menu – About

The About menu shows the software version and settings of the individual system components. Motor shows, for example, the maximum torque and whether a motor upgrade has been activated.

8.4 E-SHIFT SETTINGS

8.4.1 PINION MGU/E-SHIFT

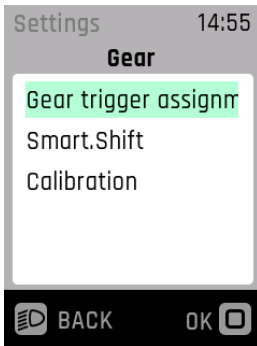

- Gear assignment – selection of shift direction for the up/down button on the FIT Remote E-Shift or on the Pinion TE1 E-Trigger or equivalent.
- Smart.Shift – Your MGU has Pinion Smart.Shift technology. This shifts the internal gear-box electronically in fractions of a second. Here you can choose from different shift settings.
- Calibration – Calibration of the gears (to be carried out after a corresponding error message).

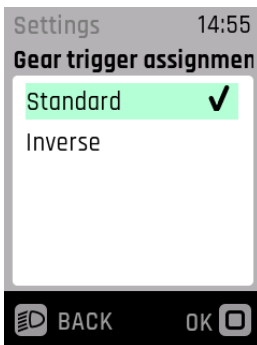

- Here you can change the switch unit on the handlebars for shifting up and shifting down according to your preference.

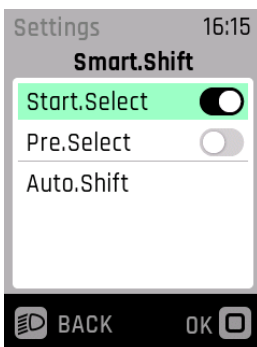

With Pinion, you can always shift gears quickly and precisely in any situation. Smart.Shift technology allows you to use different electronic shifting modes:

- Either shift gears manually and set your starting gear with **Start.Select**, or use **Pre.Select** to switch to semi-automatic gears when you are not pedaling.
- With **Auto.Shift**, the MGU switches fully automatically for you in every situation, even under pedal load.
Under the menu item **Auto.Shift**, you can adjust the automatic gear shift as needed.



NOTICE

To be able to decide when to switch fully automatically depending on the situation, activate the Auto.Shift function directly by pressing and holding the button (3 s) on the front lever of the Pinion TE1 E-Trigger or by pressing the «A» button on the FIT Remote E-Shift.

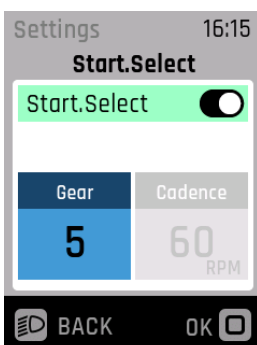

- Activating **Start.Select** allows you to set the gear that is automatically engaged when you stop. This enables energy saving when starting off.

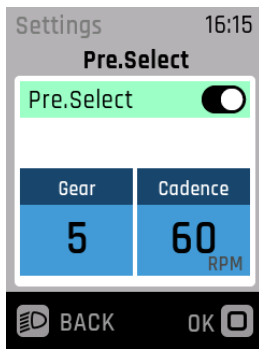

- As you roll, **Pre.Select** automatically switches to the gear that matches your speed, for example, to always have the right gear on flow trail sections, even without pedaling or manual shifting. When you stop, **Pre.Select** takes the gear specified here into account.
- Enter your target pedalling frequency (cadence) here.

**NOTICE**

Pre.Select never shifts into a gear that is lower than the speed you set here, which is also engaged when setting off.

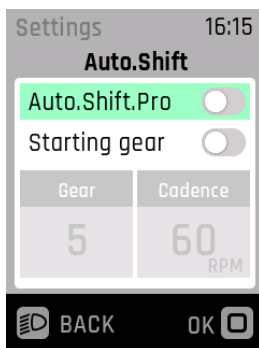

- In **Auto.Shift** mode, the MGU also switches to the appropriate speed while pedaling based on a preset desired cadence. When the **Auto.Shift** function is activated, you can increase or decrease the desired cadence in increments of 5 using the two buttons on the control unit (e.g. Pinion TE1 E-Trigger or FIT Remote E-Shift). The display shows **Auto.Shift** with "A" instead of the usual gear indicator. If you change the cadence on the control unit, this is temporarily shown in the display field for the gears on the display.

**NOTICE**

To be able to decide when to switch fully automatically depending on the situation, activate the **Auto.Shift** function directly by pressing and holding the button (3 s) on the front lever of the Pinion TE1 E-Trigger or by pressing the "A" button on the FIT Remote E-Shift.

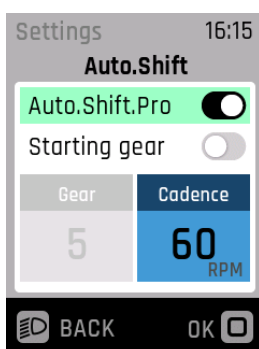

- Here you can activate **Auto.Shift.Pro**, which allows you to change gears manually even when the automatic gearshift is active. The display shows the **Auto.Shift.Pro** mode with «A+» instead of the usual gear indicator. With **Auto.Shift.Pro** you can use the switch buttons (e.g. Pinion TE1 E-Trigger or FIT Remote E-Shift) to change gears as in manual mode. This means that you no longer use the shift buttons to adjust the cadence as with a normal Auto.Shift, but instead override the automatic shifting system to be able to manually select the desired speed in any situation. If you change gear manually in **Auto.Shift.Pro** mode, the system registers your current cadence and adapts the automatic shifting to this current preference.
- Set your preferred cadence here. **Auto.Shift.Pro** adjusts the automatic gear shift at this rate until you manually select a different gear for the first time.
- If you want to return to this cadence while riding, you can do so by pressing and holding the button (3 s) on the rear lever of the Pinion TE1 E-Trigger.
- **Auto.Shift.Pro** was developed for sporty, dynamic riding and always shifts automatically to the speed that suits your cadence.

**NOTICE**

Switching to the original cadence setting is possible only with the Pinion TE1 E-Trigger and not with the FIT Remote E-Shift.

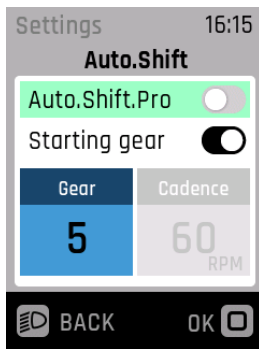

- The start gear is always active by default with **Auto.Shift** and **Auto.Shift.Pro**. This means that your e-bike automatically switches to this speed when you stop, which you can set here. If you deactivate the start gear, **Auto.Shift** or **Auto.Shift.Pro** switches to the first gear when stopping.

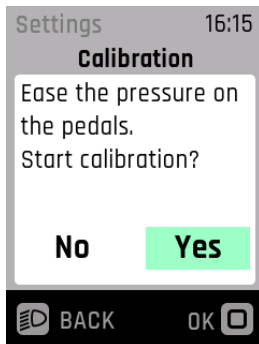

- If, for example, the cranks were disassembled, or in the unlikely event that the system loses values, this can affect shifting or riding behavior. This is where you can start the calibration. You will be guided through the calibration steps on the display.
- Follow the instructions on the display and start calibration. Do not load the pedals during calibration.

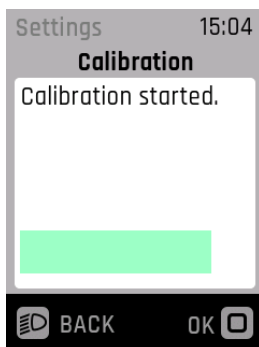

- Calibration is ongoing.

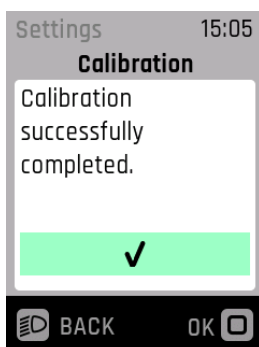

- Calibration completed successfully.

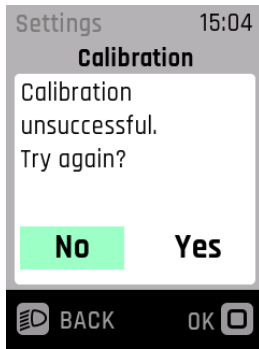

- Calibration could not be performed.

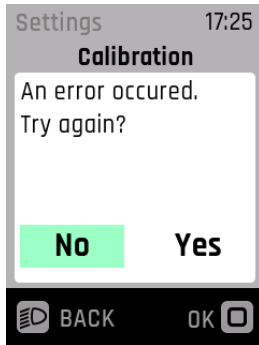

- An error occurred during calibration.

9 ERROR MESSAGES

9.1 GENERAL INFORMATION

The parts of the e-bike system are permanently monitored during use and charging. The error code is shown on the display when an error is detected. Press on the rocker switch to acknowledge the error and switch back to the default screen on the display. If the error cannot be acknowledged, use the table in section 9.3.1 to eliminate it or contact your specialist dealer. Power assistance is automatically stopped where necessary depending on the specific error code. You can still use the e-bike conventionally as a normal bicycle even if the motor no longer provides assistance. An error can be clearly categorised with the displayed category and the displayed code. A text which indicates the error category is also always displayed.

9.2 STATUS LED ON OPERATING ELEMENT AND DISPLAY

The operating element and the display each feature a status LED to indicate error statuses. The operating element's LED is located in the rocker switch. It is in the top left-hand corner in Display Compact and in the top right-hand corner in Display Comfort.

The statuses are listed in the following table:

Colour	Flash sequence	Status
Green	Continuously lit	System must be connected to the maintenance tool at the specialist dealer's.
Red	Continuously lit	Re-start the system if the status LED still lights up red. Have component replaced at the specialist dealer's.
Red	Flashing	Re-start the system if the status LED still flashes red. Have component replaced at the specialist dealer's.

9.3 INFORMATION/ERROR DISPLAY

There are four different types of error messages:

Type	Display	Effect
Information	White circle with black i	Motor assistance available The message can be acknowledged by pressing the selection rocker switch.
Warning	White triangle with black exclamation mark	Motor assistance available The message can be acknowledged by pressing the selection rocker switch.
Error	Orange triangle with black exclamation mark	No motor assistance Motor assistance is only available once the error has been rectified.
Critical error	Orange triangle with black exclamation mark and the rocker switch lights up red	No motor assistance Motor assistance is only available once the error has been rectified and the system has been restarted.

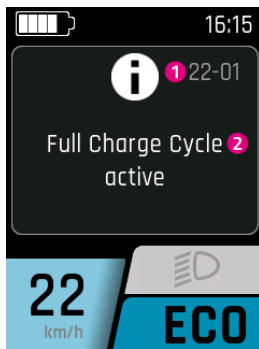
INFORMATION

1. Error code
2. Note/Recommended action

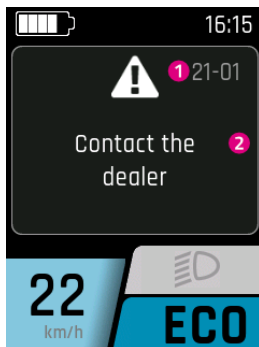
WARNING

1. Error code
2. Note/Recommended action

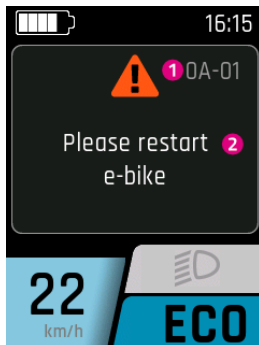
ERROR/CRITICAL ERROR

1. Error code
2. Note/Recommended action

9.3.1 ERROR TABLE

If the last two digits are listed with "xx" as a placeholder, this provides the specialist dealer with additional information for error analysis.

0A-xx up to 28-xx

Error code	Error description	Action/Restriction
0A-01, 0B-01	Remote motor communication error	<ol style="list-style-type: none"> 1. Restart the system. 2. If the problem persists, please contact your specialist dealer.
0A-02, 0B-02	Remote display communication error	<ol style="list-style-type: none"> 1. Restart the system. 2. Switch the system off. 3. Remove display from holder, check contacts and clean if necessary. 4. Re-insert the display and start the system. 5. If the problem persists, please contact your specialist dealer.
0A-03, 0A-04, 0A-05, 0A-06, 0B-03, 0B-04, 0B-05, 0B-06	Remote battery communication error	<ol style="list-style-type: none"> 1. Restart the system. 2. Switch the system off. 3. Remove the battery from the holder, check contacts and clean if necessary. 4. Re-insert the battery and start the system. 5. If the problem persists, please contact your specialist dealer.
0A-07, 0B-07	Remote speed node communication error	<ol style="list-style-type: none"> 1. Restart the system. 2. If the problem persists, please contact your specialist dealer.
0A-08, 0B-08	Remote gears communication error	<ol style="list-style-type: none"> 1. Restart the system. 2. If the problem persists, please contact your specialist dealer.
0A-0A, 0B-0A	Remote charger communication error	<ol style="list-style-type: none"> 1. Restart the system. 2. Switch the system off. 3. Disconnect the charger from the system and socket. 4. Wait until status LED goes out. 5. Check plug contacts on the e-bike and charger and clean if necessary. 6. Reconnect the charger to the socket. 7. Reconnect the charger to the system and start the system. 8. If the problem persists, please contact your specialist dealer.
0A-0B, 0B-0B	Remote lock communication error	<ol style="list-style-type: none"> 1. Restart the system. 2. If the problem persists, please contact your specialist dealer.
0C-00	Remote identification error	<ol style="list-style-type: none"> 1. Restart the system. 2. If the problem persists, please contact your specialist dealer.
0C-01	Remote motor identification error	<ol style="list-style-type: none"> 1. Restart the system. 2. If the problem persists, please contact your specialist dealer.

Error code	Error description	Action/Restriction
OC-02	Remote display identification error	<ol style="list-style-type: none"> 1. Restart the system. 2. Switch the system off. 3. Remove display from holder, check contacts and clean if necessary. 4. Re-insert the display and start the system. 5. If the problem persists, please contact your specialist dealer.
OC-03, OC-04, OC-05, OC-06	Remote battery identification error	<ol style="list-style-type: none"> 1. Restart the system. 2. Switch the system off. 3. Remove the battery from the holder, check contacts and clean if necessary. 4. Re-insert the battery and start the system. 5. If the problem persists, please contact your specialist dealer.
OC-07	Remote speed node identification error	<ol style="list-style-type: none"> 1. Restart the system. 2. If the problem persists, please contact your specialist dealer.
OC-08	Remote gears identification error	<ol style="list-style-type: none"> 1. Restart the system. 2. If the problem persists, please contact your specialist dealer.
OC-0A	Remote charger identification error	<ol style="list-style-type: none"> 1. Restart the system. 2. Switch the system off. 3. Disconnect the charger from the system and socket. 4. Wait until status LED goes out. 5. Check plug contacts on the e-bike and charger and clean if necessary. 6. Reconnect the charger to the socket. 7. Reconnect the charger to the system and start the system. 8. If the problem persists, please contact your specialist dealer.
OC-0B	Remote lock identification error	<ol style="list-style-type: none"> 1. Restart the system. 2. If the problem persists, please contact your specialist dealer.
OD-01	Motor authentication error	<ol style="list-style-type: none"> 1. Restart the system. 2. If the problem persists, please contact your specialist dealer.
OD-02	Display authentication error	<ol style="list-style-type: none"> 1. Restart the system. 2. Switch the system off. 3. Remove display from holder, check contacts and clean if necessary. 4. Re-insert the display and start the system. 5. If the problem persists, please contact your specialist dealer.
OD-03, OD-04, OD-05, OD-06	Battery authentication error	<ol style="list-style-type: none"> 1. Restart the system. 2. Switch the system off. 3. Remove the battery from the holder, check contacts and clean if necessary. 4. Re-insert the battery and start the system. 5. If the problem persists, please contact your specialist dealer.

Error code	Error description	Action/Restriction
OD-07	Speed node authentication error	<ol style="list-style-type: none"> 1. Restart the system. 2. If the problem persists, please contact your specialist dealer.
OD-08	Gears authentication error	<ol style="list-style-type: none"> 1. Restart the system. 2. If the problem persists, please contact your specialist dealer.
OD-0A	Charger authentication error	<ol style="list-style-type: none"> 1. Restart the system. 2. Switch the system off. 3. Disconnect the charger from the system and socket. 4. Wait until status LED goes out. 5. Check plug contacts on the e-bike and charger and clean if necessary. 6. Reconnect the charger to the socket. 7. Reconnect the charger to the system and start the system. 8. If the problem persists, please contact your specialist dealer.
OD-0B	Lock authentication error	<ol style="list-style-type: none"> 1. Restart the system. 2. If the problem persists, please contact your specialist dealer.
OE-xx	Remote authentication error	<ol style="list-style-type: none"> 1. Restart the system. 2. If the problem persists, please contact your specialist dealer.
OF-00	Remote update error	<ol style="list-style-type: none"> 1. Restart the system. 2. If the problem persists, please contact your specialist dealer.
OF-01	Motor update error	<ol style="list-style-type: none"> 1. Restart the system. 2. If the problem persists, please contact your specialist dealer.
OF-02	Display update error	<ol style="list-style-type: none"> 1. Restart the system. 2. Switch the system off. 3. Remove display from holder, check contacts and clean if necessary. 4. Re-insert the display and start the system. 5. If the problem persists, please contact your specialist dealer.
OF-03, OF-04, OF-05, OF-06	Battery update error	<ol style="list-style-type: none"> 1. Restart the system. 2. Switch the system off. 3. Remove the battery from the holder, check contacts and clean if necessary. 4. Re-insert the battery and start the system. 5. If the problem persists, please contact your specialist dealer.
OF-07	Speed node update error	<ol style="list-style-type: none"> 1. Restart the system. 2. If the problem persists, please contact your specialist dealer.
OF-08	Gears update error	<ol style="list-style-type: none"> 1. Restart the system. 2. If the problem persists, please contact your specialist dealer.

Error code	Error description	Action/Restriction
0F-0A	Charger update error	<ol style="list-style-type: none"> 1. Restart the system. 2. Switch the system off. 3. Disconnect the charger from the system and socket. 4. Wait until status LED goes out. 5. Check plug contacts on the e-bike and charger and clean if necessary. 6. Reconnect the charger to the socket. 7. Reconnect the charger to the system and start the system. 8. If the problem persists, please contact your specialist dealer.
0F-0B	Lock update error	<ol style="list-style-type: none"> 1. Restart the system. 2. If the problem persists, please contact your specialist dealer.
10-xx	Remote software error	<ol style="list-style-type: none"> 1. Restart the system. 2. If the problem persists, please contact your specialist dealer.
11-xx	Battery remote communication error	<ol style="list-style-type: none"> 1. Restart the system. 2. If the problem persists, please contact your specialist dealer.
12-01	Remote motor pairing error	<ol style="list-style-type: none"> 1. Restart the system. 2. If the problem persists, please contact your specialist dealer.
12-02	Remote display pairing error	<ol style="list-style-type: none"> 1. Restart the system. 2. Switch the system off. 3. Remove display from holder, check contacts and clean if necessary. 4. Re-insert the display and start the system. 5. If the problem persists, please contact your specialist dealer.
12-03, 12-04, 12-05, 12-06	Remote battery pairing error	<ol style="list-style-type: none"> 1. Restart the system. 2. Switch the system off. 3. Remove the battery from the holder, check contacts and clean if necessary. 4. Re-insert the battery and start the system. 5. If the problem persists, please contact your specialist dealer.
12-07	Remote speed node pairing error	<ol style="list-style-type: none"> 1. Restart the system. 2. If the problem persists, please contact your specialist dealer.
12-08	Remote gears pairing error	<ol style="list-style-type: none"> 1. Restart the system. 2. If the problem persists, please contact your specialist dealer.

Error code	Error description	Action/Restriction
12-0A	Remote charger pairing error	<ol style="list-style-type: none"> 1. Restart the system. 2. Switch the system off. 3. Disconnect the charger from the system and socket. 4. Wait until status LED goes out. 5. Check plug contacts on the e-bike and charger and clean if necessary. 6. Reconnect the charger to the socket. 7. Reconnect the charger to the system and start the system. 8. If the problem persists, please contact your specialist dealer.
12-0B	Remote lock pairing error	<ol style="list-style-type: none"> 1. Restart the system. 2. If the problem persists, please contact your specialist dealer.
13-xx	Remote internal error	<ol style="list-style-type: none"> 1. Restart the system. 2. If the problem persists, please contact your specialist dealer.
14-xx	Remote configuration error	<ol style="list-style-type: none"> 1. Restart the system. 2. If the problem persists, please contact your specialist dealer.
15-01	Remote motor pairing error	<ol style="list-style-type: none"> 1. Restart the system. 2. If the problem persists, please contact your specialist dealer.
15-02	Remote display pairing error	<ol style="list-style-type: none"> 1. Restart the system. 2. Switch the system off. 3. Remove display from holder, check contacts and clean if necessary. 4. Re-insert the display and start the system. 5. If the problem persists, please contact your specialist dealer.
15-03, 15-04, 15-05, 15-06	Remote battery pairing error	<ol style="list-style-type: none"> 1. Restart the system. 2. Switch the system off. 3. Remove the battery from the holder, check contacts and clean if necessary. 4. Re-insert the battery and start the system. 5. If the problem persists, please contact your specialist dealer.
15-07	Remote speed node pairing error	<ol style="list-style-type: none"> 1. Restart the system. 2. If the problem persists, please contact your specialist dealer.
15-08	Remote gears pairing error	<ol style="list-style-type: none"> 1. Restart the system. 2. If the problem persists, please contact your specialist dealer.

Error code	Error description	Action/Restriction
15-0A	Remote charger pairing error	<ol style="list-style-type: none"> 1. Restart the system. 2. Switch the system off. 3. Disconnect the charger from the system and socket. 4. Wait until status LED goes out. 5. Check plug contacts on the e-bike and charger and clean if necessary. 6. Reconnect the charger to the socket. 7. Reconnect the charger to the system and start the system. 8. If the problem persists, please contact your specialist dealer.
15-0B	Remote lock pairing error	<ol style="list-style-type: none"> 1. Restart the system. 2. If the problem persists, please contact your specialist dealer.
16-00	Remote theft detection	<ol style="list-style-type: none"> 1. Restart the system. 2. If the problem persists, please contact your specialist dealer.
16-01	Motor theft detection	<ol style="list-style-type: none"> 1. Restart the system. 2. If the problem persists, please contact your specialist dealer.
16-02	Display theft detection	<ol style="list-style-type: none"> 1. Restart the system. 2. Switch the system off. 3. Remove display from holder, check contacts and clean if necessary. 4. Re-insert the display and start the system. 5. If the problem persists, please contact your specialist dealer.
16-03, 16-04, 16-05, 16-06	Battery theft detection	<ol style="list-style-type: none"> 1. Restart the system. 2. Switch the system off. 3. Remove the battery from the holder, check contacts and clean if necessary. 4. Re-insert the battery and start the system. 5. If the problem persists, please contact your specialist dealer.
16-07	Speed node theft detection	<ol style="list-style-type: none"> 1. Restart the system. 2. If the problem persists, please contact your specialist dealer.
16-08	Gears theft detection	<ol style="list-style-type: none"> 1. Restart the system. 2. If the problem persists, please contact your specialist dealer.
16-0A	Charger theft detection	<ol style="list-style-type: none"> 1. Restart the system. 2. Switch the system off. 3. Disconnect the charger from the system and socket. 4. Wait until status LED goes out. 5. Check plug contacts on the e-bike and charger and clean if necessary. 6. Reconnect the charger to the socket. 7. Reconnect the charger to the system and start the system. 8. If the problem persists, please contact your specialist dealer.

Error code	Error description	Action/Restriction
16-0B	Lock theft detection	<ol style="list-style-type: none"> 1. Restart the system. 2. If the problem persists, please contact your specialist dealer.
17-00	Remote defective component	<ol style="list-style-type: none"> 1. Restart the system. 2. If the problem persists, please contact your specialist dealer.
17-01	Motor defective component	<ol style="list-style-type: none"> 1. Restart the system. 2. If the problem persists, please contact your specialist dealer.
17-02	Display defective component	<ol style="list-style-type: none"> 1. Restart the system. 2. Switch the system off. 3. Remove display from holder, check contacts and clean if necessary. 4. Re-insert the display and start the system. 5. If the problem persists, please contact your specialist dealer.
17-03, 17-04, 17-05, 17-06	Battery defective component	<ol style="list-style-type: none"> 1. Restart the system. 2. Switch the system off. 3. Remove the battery from the holder, check contacts and clean if necessary. 4. Re-insert the battery and start the system. 5. If the problem persists, please contact your specialist dealer.
17-07	Speed node defective component	<ol style="list-style-type: none"> 1. Restart the system. 2. If the problem persists, please contact your specialist dealer.
17-08	Gears defective component	<ol style="list-style-type: none"> 1. Restart the system. 2. If the problem persists, please contact your specialist dealer.
17-0A	Charger defective component	<ol style="list-style-type: none"> 1. Restart the system. 2. Switch the system off. 3. Disconnect the charger from the system and socket. 4. Wait until status LED goes out. 5. Check plug contacts on the e-bike and charger and clean if necessary. 6. Reconnect the charger to the socket. 7. Reconnect the charger to the system and start the system. 8. If the problem persists, please contact your specialist dealer.
17-0B	Lock defective component	<ol style="list-style-type: none"> 1. Restart the system. 2. If the problem persists, please contact your specialist dealer.
18-00	Remote start error	<ol style="list-style-type: none"> 1. Restart the system. 2. If the problem persists, please contact your specialist dealer.
18-01	Motor start error	<ol style="list-style-type: none"> 1. Restart the system. 2. If the problem persists, please contact your specialist dealer.

Error code	Error description	Action/Restriction
18-02	Display start error	<ol style="list-style-type: none"> 1. Restart the system. 2. Switch the system off. 3. Remove display from holder, check contacts and clean if necessary. 4. Re-insert the display and start the system. 5. If the problem persists, please contact your specialist dealer.
18-03, 18-04, 18-05, 18-06	Battery start error	<ol style="list-style-type: none"> 1. Restart the system. 2. Switch the system off. 3. Remove the battery from the holder, check contacts and clean if necessary. 4. Re-insert the battery and start the system. 5. If the problem persists, please contact your specialist dealer.
18-07	Speed node start error	<ol style="list-style-type: none"> 1. Restart the system. 2. If the problem persists, please contact your specialist dealer.
18-08	Gears start error	<ol style="list-style-type: none"> 1. Restart the system. 2. If the problem persists, please contact your specialist dealer.
18-0A	Charger start error	<ol style="list-style-type: none"> 1. Restart the system. 2. Switch the system off. 3. Disconnect the charger from the system and socket. 4. Wait until status LED goes out. 5. Check plug contacts on the e-bike and charger and clean if necessary. 6. Reconnect the charger to the socket. 7. Reconnect the charger to the system and start the system. 8. If the problem persists, please contact your specialist dealer.
18-0B	Lock start error	<ol style="list-style-type: none"> 1. Restart the system. 2. If the problem persists, please contact your specialist dealer.
19-xx	Remote safety error	<ol style="list-style-type: none"> 1. Restart the system. 2. If the problem persists, please contact your specialist dealer.
1A-01	Manipulation detected	<ol style="list-style-type: none"> 1. Check mounting position of the magnet and speed sensor. 2. Restart the system. 3. If the problem persists, please contact your specialist dealer.
1A-02	Manipulation detected Speed sensor missing	<ol style="list-style-type: none"> 1. Check mounting position of the magnet and speed sensor. 2. Restart the system. 3. If the problem persists, please contact your specialist dealer.
1B-xx	System voltage error	<ol style="list-style-type: none"> 1. Check whether the correct battery is installed (36V/48V). 2. Restart the system. 3. If the problem persists, please contact your specialist dealer.

Error code	Error description	Action/Restriction
1C-xx	Bluetooth module error	<ol style="list-style-type: none"> 1. Restart the system. 2. Restart FIT E-Bike Control (app), update if necessary. 3. If the problem persists, please contact your specialist dealer.
1D-xx	EMS mode active	<ol style="list-style-type: none"> 1. Restart the system. 2. If the problem persists, please contact your specialist dealer.
1E-xx	OEM mode active	<ol style="list-style-type: none"> 1. Restart the system. 2. If the problem persists, please contact your specialist dealer.
1F-xx	TEST mode active	<ol style="list-style-type: none"> 1. Restart the system. 2. If the problem persists, please contact your specialist dealer.
20-xx	Reserve mode active (info text)	<ol style="list-style-type: none"> 1. Charge the battery. 2. If the problem persists, please contact your specialist dealer.
21-xx	Lock error	<ol style="list-style-type: none"> 1. Restart the system. 2. If the problem persists, please contact your specialist dealer.
22-xx	Full charge cycle active	Information: Battery is charged for calibration despite Long Life mode 100%.
23-09	Tire pressure sensor error Battery weak front	Sensor needs to be replaced soon, please contact your specialist dealer.
23-0A	Tire pressure sensor error Battery weak rear	Sensor needs to be replaced soon, please contact your specialist dealer.
23-0B	Tire pressure sensor error Battery weak front right	Sensor needs to be replaced soon, please contact your specialist dealer.
23-0C	Tire pressure sensor error Battery weak rear right	Sensor needs to be replaced soon, please contact your specialist dealer.
23-xx	Tire pressure sensor error	Sensor may need to be replaced, please contact your specialist dealer.
24-01	Charger multi-battery error	<ol style="list-style-type: none"> 1. Charge each battery individually. 2. Have the charger software update done at your specialist dealer.
25-xx	1-Wire communication error	<ol style="list-style-type: none"> 1. Restart the system. 2. If the problem persists, please contact your specialist dealer.
26-xx	Battery lock (ABUS) error	<ol style="list-style-type: none"> 1. Restart the system. 2. If the problem persists, please contact your specialist dealer.

29-xx up to 47-xx

Error code	Error description	Action/Restriction
29-xx	Display communication error	<ol style="list-style-type: none"> 1. Restart the system. 2. If the problem persists, please contact your specialist dealer.
2A-xx	Display software error	<ol style="list-style-type: none"> 1. Restart the system. 2. Switch the system off. 3. Remove display from holder, check contacts and clean if necessary. 4. Replace the display and start the system. 5. If the problem persists, please contact your specialist dealer.
2B-xx	Display authentication error	<ol style="list-style-type: none"> 1. Restart the system. 2. Switch the system off. 3. Remove display from holder, check contacts and clean if necessary. 4. Replace the display and start the system. 5. If the problem persists, please contact your specialist dealer.
2C-xx	Display internal error	<ol style="list-style-type: none"> 1. Restart the system. 2. If the problem persists, please contact your specialist dealer.
2D-xx	Display identification error	<ol style="list-style-type: none"> 1. Restart the system. 2. Switch the system off. 3. Remove display from holder, check contacts and clean if necessary. 4. Replace the display and start the system. 5. If the problem persists, please contact your specialist dealer.
2E-01	Display overheated Screen brightness reduced	<ol style="list-style-type: none"> 1. Cool display by riding. 2. Protect the display from direct sunlight.

48-xx 66-xx (Pinion)

Error code	Error description	Action/Restriction
48-xx	Motor communication error	<ol style="list-style-type: none"> 1. Check plug contacts on the battery and bicycle and clean if necessary. 2. Restart the system. 3. If the problem persists, please contact your specialist dealer.
49-07	Motor error E-bike battery not ready	<ol style="list-style-type: none"> 1. Switch the system off. 2. Remove the battery. 3. Check plug contacts on the battery and e-bike and clean if necessary. 4. Insert the battery. 5. Restart the system. 6. If the problem persists, please contact your specialist dealer.
49-09, 49-0A	Motor error	<ol style="list-style-type: none"> 1. Check if one or both trigger buttons are pressed constantly, if so: Release buttons. 2. Restart the system. 3. If the problem persists, please contact your specialist dealer.

Error code	Error description	Action/Restriction
49-0B	Motor error Pinion change detected	<ol style="list-style-type: none"> 1. Restart the system. 2. If the problem persists, please contact your specialist dealer.
49-0C	Motor error Tampering detected	<ol style="list-style-type: none"> 1. Check mounting position of the magnet and speed sensor. 2. Start calibration via display gear menu (follow instructions). 3. Restart the system. 4. If the problem persists, please contact your specialist dealer.
49-0D	Motor error	<ol style="list-style-type: none"> 1. Restart the system. 2. Check light cables and lights for short circuit; check installed lamps for compatibility with the bike and replace them if necessary. 3. If the problem persists, please contact your specialist dealer.
49-xx	Motor error	<ol style="list-style-type: none"> 1. Restart the system. 2. If the problem persists, please contact your specialist dealer.
4A-xx	Motor temperature error	<ol style="list-style-type: none"> 1. Switch the system off. 2. Allow the motor to cool down and, if necessary, clean the motor's ventilation vents. 3. Switch on the system. 4. If the problem persists, please contact your specialist dealer.
4B-xx	Motor speed sensor error	<ol style="list-style-type: none"> 1. Restart the system. 2. Check mounting position of the magnet and speed sensor. 3. If the problem persists, please contact your specialist dealer.
4C-xx	Motor torque sensor error	<ol style="list-style-type: none"> 1. Restart the system with no pressure on the pedals. 2. If the problem persists, please contact your specialist dealer.
4D-03	Gear error Release pedals	<ol style="list-style-type: none"> 1. Release pedals so that wheel can shift into the required speed for the pushing aid, wait 3 seconds. 2. Restart the system with no pressure on the pedals. 3. Start calibration via display gear menu (follow instructions). 4. If the problem persists, please contact your specialist dealer.
4D-08	Gear error Stop, release pedals	<ol style="list-style-type: none"> 1. Stop the bike, release the pedals, wait 3 seconds. 2. Restart the system with no pressure on the pedals. 3. Start calibration via display gear menu (follow instructions). 4. If the problem persists, please contact your specialist dealer.

Error code	Error description	Action/Restriction
4D-11	Gear error Shifting blocked for 1 min	<ol style="list-style-type: none"> 1. Wait 1 minute. 2. Restart the system. 3. Start calibration via display gear menu (follow instructions). 4. If the problem persists, please contact your specialist dealer.
4D-xx	Gear error	<ol style="list-style-type: none"> 1. Release pedals, wait 3 seconds. 2. Restart the system with no pressure on the pedals. 3. Start calibration via display gear menu (follow instructions). 4. If the problem persists, please contact your specialist dealer.
4E-xx	Motor cadence sensor error	<ol style="list-style-type: none"> 1. Restart the system. 2. If the problem persists, please contact your specialist dealer.
4F-xx	Motor authentication error	<ol style="list-style-type: none"> 1. Restart the system. 2. If the problem persists, please contact your specialist dealer.
51-01, 51-02	Motor voltage error E-bike battery voltage error	<ol style="list-style-type: none"> 1. Restart the system. 2. Check lights and associated cables for damage. 3. If the problem persists, please contact your specialist dealer.
52-xx	Motor angle sensor error	<ol style="list-style-type: none"> 1. Restart the system. 2. If the problem persists, please contact your specialist dealer.
53-xx	Motor software error	<ol style="list-style-type: none"> 1. Restart the system. 2. If the problem persists, please contact your specialist dealer.

67-xx up to 85-xx and FF-xx

Error code	Error description	Action/Restriction
67-01, 67-03, 67-06, 67-12	Battery voltage error	<ol style="list-style-type: none"> 1. Restart the system. 2. If the problem persists, please contact your specialist dealer.
67-02, 67-07, 67-08, 67-09, 67-13	Battery voltage error	<ol style="list-style-type: none"> 1. Connect the battery to the charger. 2. Restart the system. 3. If the problem persists, please contact your specialist dealer.
67-05, 67-0A, 67-0B, 67-11, 67-15	Battery voltage error	<ol style="list-style-type: none"> 1. Restart the system. 2. If the problem persists, please contact your specialist dealer.
68-01, 68-05, 68-06, 68-07, 68-09, 68-16, 68-17, 68-18, 68-19, 68-1A	Battery current error Discharging error	<ol style="list-style-type: none"> 1. Switch the system off. 2. Remove the battery. 3. Re-insert battery. 4. Start the system. 5. If the problem persists, please contact your specialist dealer.

Error code	Error description	Action/Restriction
68-02, 68-03, 68-08, 68-0A	Battery current error Charging error	<ol style="list-style-type: none"> 1. Disconnect the charger from the battery. 2. Reconnect the charger and start charging. 3. If the problem persists, please contact your specialist dealer.
68-04, 68-11, 68-12	Battery current error Short circuit	<ol style="list-style-type: none"> 1. Switch the system off. 2. Remove the battery. 3. Re-insert battery. 4. Start the system. 5. If the problem persists, please contact your specialist dealer.
68-0B, 68-13	Battery current error Overcurrent error	<ol style="list-style-type: none"> 1. Switch the system off. 2. Remove the battery. 3. Re-insert battery. 4. Start the system. 5. If the problem persists, please contact your specialist dealer.
68-14	Battery current error Start error	<ol style="list-style-type: none"> 1. Switch the system off. 2. Remove the battery. 3. Re-insert battery. 4. Start the system. 5. If the problem persists, please contact your specialist dealer.
68-15	Battery current error	<ol style="list-style-type: none"> 1. Switch the system off. 2. Remove the battery. 3. Re-insert battery. 4. Start the system. 5. If the problem persists, please contact your specialist dealer.
69-01, 69-08	Battery temperature error	<ol style="list-style-type: none"> 1. Disconnect the charger from the battery. 2. Allow the battery to cool down (> 60 minutes). 3. Restart the charging process. 4. If the problem persists, please contact your specialist dealer.
69-02, 69-09	Battery temperature error	<ol style="list-style-type: none"> 1. Turn off the e-bike. 2. Allow the battery to cool down (> 60 minutes). 3. Start the system. 4. If the problem persists, please contact your specialist dealer.
69-03, 69-0C	Battery temperature error	<ol style="list-style-type: none"> 1. Bring the battery to a warmer place. 2. Allow the battery to warm up (> 30 minutes). 3. Restart the charging process. 4. If the problem persists, please contact your specialist dealer.
69-04, 69-0D	Battery temperature error	<ol style="list-style-type: none"> 1. System operating below the permissible temperature. 2. Allow the battery to warm up in a warm environment (> 30 minutes). 3. Start the system. 4. If the problem persists, please contact your specialist dealer.

Error code	Error description	Action/Restriction
69-05, 69-0A, 69-0F, 69-11, 69-12	Battery temperature error	<ol style="list-style-type: none"> 1. Turn off the e-bike. 2. Allow the battery to cool down (> 60 minutes). 3. Start the system. 4. If the problem persists, please contact your specialist dealer.
69-06, 69-0B, 69-10	Battery temperature error	<ol style="list-style-type: none"> 1. System operating below the permissible temperature. 2. Allow the battery to warm up in a warm environment (> 30 minutes). 3. Start the system. 4. If the problem persists, please contact your specialist dealer.
69-13	Battery temperature error	<ol style="list-style-type: none"> 1. Start the system. 2. If the problem persists, please contact your specialist dealer.
6A-xx	Battery software error	<ol style="list-style-type: none"> 1. Check whether the correct battery is installed (36V/48V). 2. Check the plug contacts on the battery and bicycle and clean if necessary. 3. Restart the system. 4. If the problem persists, please contact your specialist dealer.
6B-xx	Battery hardware error	<ol style="list-style-type: none"> 1. Restart the system. 2. If the problem persists, please contact your specialist dealer.
6C-xx	Battery communication error	<ol style="list-style-type: none"> 1. Check whether the correct battery is installed (36V/48V). 2. Check the plug contacts on the battery and bicycle and clean if necessary. 3. Restart the system. 4. If the problem persists, please contact your specialist dealer.
6D-xx	Battery authentication error	<ol style="list-style-type: none"> 1. Check whether the correct battery is installed (36V/48V). 2. Check the plug contacts on the battery and bicycle and clean if necessary. 3. Restart the system. 4. If the problem persists, please contact your specialist dealer.
6E-xx	Battery unknown error	<ol style="list-style-type: none"> 1. Check whether the correct battery is installed (36V/48V). 2. Check the plug contacts on the battery and bicycle and clean if necessary. 3. Restart the system. 4. If the problem persists, please contact your specialist dealer.
FF-xx	Battery start error	<ol style="list-style-type: none"> 1. Restart the system. 2. If the problem persists, please contact your specialist dealer.

86-xx up to 8A-xx

Error code	Error description	Action/Restriction
86-xx	Speed node software error	<ol style="list-style-type: none"> 1. Restart the system. 2. If the problem persists, please contact your specialist dealer.
87-xx	Speed node authentication error	<ol style="list-style-type: none"> 1. Restart the system. 2. If the problem persists, please contact your specialist dealer.

95-xx up to 99-xx

Error code	Error description	Action/Restriction
95-xx	Charger software error	<ol style="list-style-type: none"> 1. Check whether the correct battery is installed (36V/48V). 2. Disconnect the charger from the system and socket. 3. Wait until status LED goes out. 4. Reconnect the charger to the socket. 5. Reconnect the charger to the system. 6. If the problem persists, please contact your specialist dealer.
96-xx	Charger voltage error	<ol style="list-style-type: none"> 1. Check whether the correct battery is installed (36V/48V). 2. Disconnect the charger from the system and socket. 3. Wait until status LED goes out. 4. Reconnect the charger to the socket. 5. Reconnect the charger to the system. 6. If the problem persists, please contact your specialist dealer.
97-xx	Charger current error	<ol style="list-style-type: none"> 1. Check whether the correct battery is installed (36V/48V). 2. Disconnect the charger from the system and socket. 3. Wait until status LED goes out. 4. Reconnect the charger to the socket. 5. Reconnect the charger to the system. 6. If the problem persists, please contact your specialist dealer.
98-xx	Charger temperature error	<ol style="list-style-type: none"> 1. Disconnect the charger from the battery. 2. Allow the charger to cool (> 30 minutes). 3. Restart the charging process. 4. If the problem persists, please contact your specialist dealer.

8B-xx up to 92-xx

Error code	Error description	Action/Restriction
8B-xx	Gears authentication error	<ol style="list-style-type: none"> 1. Restart the system. 2. If the problem persists, please contact your specialist dealer.

Error code	Error description	Action/Restriction
8C-06	Gears hardware error Calibration required	<ol style="list-style-type: none"> 1. Calibrate the gears as described in the corresponding operating instructions. 2. If the problem persists, please contact your specialist dealer.
8C-xx	Gears hardware error	<ol style="list-style-type: none"> 1. Restart the system. 2. If the problem persists, please contact your specialist dealer.

9A-xx up to 9E-xx

Error code	Error description	Action/Restriction
9A-xx	Lock authentication error	<ol style="list-style-type: none"> 1. Check whether an original FIT lock is installed. 2. Restart the system. 3. If the problem persists, please contact your specialist dealer.
9B-xx	Lock blocked	<ol style="list-style-type: none"> 1. Restart the system. 2. Check lock for contamination. 3. If the problem persists, please contact your specialist dealer.
9C-xx	Lock hardware error	<ol style="list-style-type: none"> 1. Restart the system. 2. Check lock for damage. 3. If the problem persists, please contact your specialist dealer.
9D-xx	Lock movement detected	<ol style="list-style-type: none"> 1. Resend lock command 2. Restart the system. 3. Check lock for damage. 4. If the problem persists, please contact your specialist dealer.

10 CLEANING AND SERVICING

10.1 BASIC CLEANING

10.1.1 CLEANING THE DISPLAY AND OPERATING ELEMENT

**NOTICE**

The display and operating element will be permanently damaged if water enters them.

- Never immerse the display or operating element in water.
- Never clean with a pressure washer, water jet or compressed air.
- Never use cleaning agents.
- Remove the display from the e-bike before cleaning.
- Carefully clean the display and operating element with a soft, damp cloth.

11 TROUBLESHOOTING, FAULT CLEARANCE AND REPAIR

11.1 TROUBLESHOOTING AND FAULT CLEARANCE

11.1.1 DRIVE SYSTEM OR DISPLAY DOES NOT START UP

If the display and/or the drive system do not start up, proceed as follows:

1. Check if the battery is inserted correctly. If not, insert the battery correctly.
2. Start the drive system.
3. If the drive system does not start, remove the battery, check the charging status and charge if necessary.
4. Clean all contacts with a soft cloth.
5. Insert the battery.
6. Start the drive system.
7. If the drive system does not start, contact the specialist dealer.



NOTICE

If the battery terminal contacts are heavily soiled/oxidized. Take your e-bike to a specialist dealer for a detailed check.

11.1.2 ERRORS IN THE ASSISTANCE SYSTEM

Symptom	Cause	Remedy
Assistance is not available.	Is the speed too high?	1. Check display screen. The motor assistance is only active up to the maximum speed for which the e-bike is approved.
	Is the battery charged sufficiently?	2. Check battery is charged. 3. Recharge the battery if it is almost flat.
	The motor may become too hot during rides at high temperatures, up long inclines or when carrying a heavy load for a long time.	4. Switch off the drive system. 5. Wait a moment and then check again.
	The rechargeable battery, display or operating element may be connected incorrectly, or one or more of them may have a problem.	6. Contact your specialist dealer.
Assistance is not available.	Are the pedals being pushed?	1. Your e-bike is not a motorbike. Push the pedals.
	Is the system switched on?	2. Press on-off button (operating element) to switch on the system.
	Is the level of assistance set to OFF ?	3. Set the level of assistance to FLY, FLEX, FLOW or ECO . 4. Contact your specialist dealer if you still feel that the no assistance is being supplied.

Symptom	Cause	Remedy
The assisted journey distance is too short.	The battery does not perform as well in winter weather.	This does not indicate a problem.
	The journey distance can be shorter depending on the road conditions, the level of assistance and the total light usage time.	1. Check battery is charged. 2. Recharge the battery if it is almost flat.
	Is the battery fully charged?	3. If the distance covered with a fully charged battery has become shorter, the battery may be affected. Replace the battery with a new one.
	The battery is a consumable. Repeated charging and long periods of use cause the battery to degrade (loss of power).	4. If the distance you can cover with one single charge is very short, replace the battery with a new one.
It is difficult to pedal.	Are the tires pumped to an adequate pressure?	1. Pump up tires.
	Is the level of assistance set to OFF ?	2. Set the level of assistance to FLY, FLEX, FLOW or ECO .
	The battery charge might be low.	3. Check battery is charged. 4. Recharge the battery if it is almost flat.
	Have you switched on the system with your foot on the pedal?	5. Switch on the system again without applying pressure to the pedals. 6. If assistance is still not supplied, contact your specialist dealer.

11.2 REPAIR

Special expertise and tools are required for many repairs. That is why only a specialist dealer may perform repairs.

11.2.1 ORIGINAL PART

The individual e-bike parts have been carefully selected and matched to one other. Only original parts must be used for maintenance and repair. Observe the operating instructions for the new components.

11.2.2 REPLACING THE LIGHTS

Replace components with ones in the right power class.

11.2.3 ADJUSTING THE HEADLIGHT

The headlight must be positioned so that its beam hits the road surface 10 m in front of the e-bike.

12 RECYCLING AND DISPOSAL

12.1 DISPOSAL



Mechanical and electrical equipment, accessories and packaging should be recycled in an environmentally sound manner. Don't throw them in the garbage!



Only for EU countries: According to European Directives 2012/19/EU, 2006/66/EC and their transposition into national law, defective or unusable waste electrical and electronic equipment, rechargeable batteries and batteries must be collected separately and recycled in an environmentally sound manner.