



4 A Charger



User Manual
EN

1 Safety



These instruction contains information that you must observe for your personal safety and to prevent personal injury and damage to property. They are highlighted by warning triangles and shown below according to the degree of danger.

- ▶ Read the instructions completely before start-up and use. This will help you to avoid hazards and errors.
- ▶ Keep the manual for future reference. This user manual is an integral part of the product and must be handed over to third parties in case of resale.

NOTE

Also observe the additional documentation for the other components of the HPR50 drive system as well as the documentation enclosed with the e-bike.

1.1 Hazard classification

DANGER

The signal word indicates a danger with a **high** degree of risk which will result in death or serious injury if not avoided.

WARNING

The signal word indicates a danger with a **medium** level of risk which will result in death or serious injury if not avoided.

CAUTION

The signal word indicates a danger with a **low** level of risk which could result in a minor or moderate injury if not avoided.













NOTE

A note in the sense of this instruction is important information about the product or the respective part of the instruction to which special attention is to be drawn.



1.2 IMPORTANT SAFETY INSTRUCTIONS

WARNING



When using this product, basic precautions should always be followed, including the following:

-  Read all the instructions before using the product.
-  Do not put fingers or hands into the product.
-  Only use the original TQ Charger (FSP235-14S4AC8C) to charge the original Battery and Range Extender V01.
-  Before each charging process, check that the Charger cable and plug are not damaged.
-  Only operate the Charger in dry rooms.
-  Keep the Charger clean. Contamination could cause an electric shock.
-  The Battery and Range Extender must never be charged unattended.
-  To reduce the risk of injury, close supervision is necessary when the Charger is used near children.
-  Do not attempt to modify or repair the product. Check further detail in Chapter "1.3 Intended Use".
-  The Battery and Range Extender are intended to be charged when the ambient temperature is between 0 °C (32 °F) and 40 °C (104 °F). Never charge the Battery and the Range Extender when ambient temperatures are outside this range.
-  This equipment is not intended to be used at ambient temperatures less than 0 °C (32 °F) or above ambient temperatures of 40 °C (104 °F).
-  Only use this product within following temperature limits
Charging: 0 °C to 40 °C / 32 °F to 104 °F
Storage: 0 °C to 40 °C / 32 °F to 104 °F

1.2.1 INSTRUCTIONS PERTAINING TO RISK OF FIRE

-  Do not operate the Charger on easily combustible surfaces (e.g. paper, textiles, etc.) or in combustible environments. There is a risk of fire due to the heating of the Charger during charging.
-  To reduce the risk of fire, connect only to a circuit provided with 20 amperes maximum branch circuit overcurrent protection in accordance with the National Electrical Code, ANSI/NFPA 70.

1.2.2 INSTRUCTIONS PERTAINING TO ELECTRIC SHOCK

-  Do not use this product if the flexible power cord or output cable is frayed, has broken insulation, or any other signs of damage.
-  Never open the Charger. In the event of a fault, have the Charger checked by an authorized bicycle dealer.
-  Protect the Charger from moisture. Otherwise there is a risk of electric shock.

SAVE THESE INSTRUCTIONS

1.3 Intended Use

 The TQ Charger (FSP235-14S4AC8C) is intended exclusively for charging the Battery and the optional Range Extender of the HPR50 drive system and must not be used for other purposes. The terms Battery or Range Extender refer exclusively to the original Battery pack included in the scope of delivery of the e-bike or the optional Range Extender.

Any other use or use that goes beyond this is considered improper and will result in the loss of the warranty. In case of non-intended use, TQ-Systems GmbH assumes no liability for any damage that may occur and no warranty for proper and functional operation of the product.

Intended use also includes observing these instructions and all information contained therein as well as the information on intended use in the supplementary documents enclosed with the e-bike.

Faultless and safe operation of the product requires proper transport, storage, installation and operation.

2 Technical Data

Input power supply voltage	100 V AC to 240 V AC
Input power supply frequency	50 Hz to 60 Hz
Power plug versions	EU, USA, UK, NZL/AUS
Output voltage (max.)	58.8 V DC
Charge current (max.)	4 A
Dimensions	177 mm x 86 mm x 32.2 mm / 6.97" x 3.39" x 1.27"
Protection class	IP40 (Indoor use only)
Operating and storage temperature	0 °C to 40 °C / 32 °F to 104 °F
Max. height during operation	3000 m / 9843 ft above sea level
Weight	700 g / 1.54 lbs incl. power cable

Tab. 1: Technical data – TQ Charger (FSP235-14S4AC8C)

3 OPERATION

3.1 Battery / Range Extender charging

WARNING

Fire or electric shock hazard due to damage to Battery, Range Extender, Charger, cable and plug

- ▶ Never use the Charger if you notice any damage to the Battery, Range Extender, Charger, cables or connectors.
- ▶ Only perform the charging process in a place where there are no flammable materials in surrounding.
- ▶ Never leave the charging process unattended.
- ▶ Only use the original TQ Charger (FSP235-14S4AC8C) to charge the Battery or Range Extender.
- ▶ Further safety warnings regarding Risk of Fire, Electric Shock or Injury to persons can be found in the section: "1.2 Important Safety Instructions".
- ▶ Do not attempt to modify or repair the product. Check further detail in Chapter "1.3 Intended Use".
- ▶ Only use this product within following temperature limits
Charging: 0 °C to 40 °C / 32 °F to 104 °F
Storage: 0 °C to 40 °C / 32 °F to 104 °F

Connect the Charger to the power supply

- ▶ Insert the small device plug (item. 1 in Fig. 1) of the country-specific power cord into the socket (item 2 in Fig. 1) on the Charger.
- ▶ Connect the mains plug of the Charger to the mains socket.

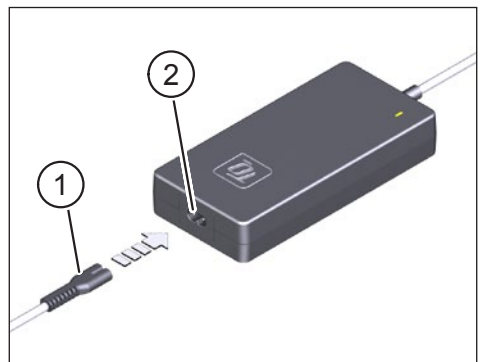

Fig. 1: Connect the Charger to the power supply

Integrated Battery charging

- ▶ Open the cover (item 1 in Fig. 2) on the charging port (item 2 in Fig. 2) in the bike frame.
- ▶ Check that the contacts in the charging port are free of dirt and clean them if necessary.
- ▶ Align the charging plug (item 3 in Fig. 2) of the Charger so that the plug codes of the charging plug and charging port match (see Fig. 2).
- ▶ Plug in the charging plug of the Charger into the charging port of the Battery.
- ▶ Remove the charging plug of the Charger from the charging port of the Battery when charging is complete.
- ▶ Close the cover on the charging port after the charging process has been completed.
- ▶ Disconnect the Charger from the power supply system.

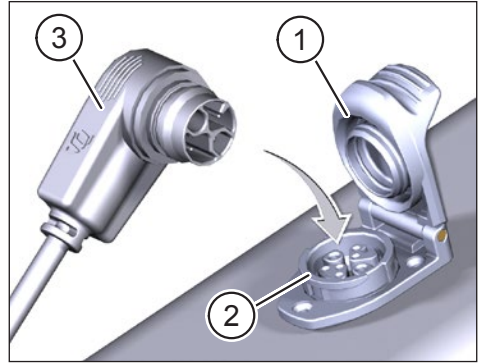

Fig. 2: Integrated Battery charging

NOTE

The drive system detects whether the Charger is connected to the charging port of the Battery in the bike frame. In this case, the drive system is deactivated during the charging process for safety reasons.

Optional Range Extender Charging

NOTE

- When connecting the Charger to the optional Range Extender, it is checked whether the Range Extender is connected to the charging port of the Battery in the bike frame. In this case, the drive system is deactivated during the charging process for safety reasons.
- The charging system detects whether the Range Extender is connected to the charging port of the Battery in the bicycle frame. In this case, both are charged, first the integrated Battery and then the optional Range Extender.

⚠ CAUTION

Risk of accident due to activated drive system during charging process

- ▶ Always connect the Range Extender to the charging port of the Battery in the bike frame when you have installed the Range Extender on the bike.

This is the only way to ensure that the drive system is deactivated during charging. Otherwise, there is a risk that you may start the drive system during charging and the plugged-in charging cable may cause a fall when you start driving.

- ▶ Open the cover (item 1 in Fig. 3) on the charging port of the Range Extender.
- ▶ Check that the contacts in the charging port (item 2 in Fig. 3) are free of dirt and clean them if necessary.
- ▶ Insert the charging plug (item 3 in Fig. 3) of the Charger into the charging port of the Range Extender.
- ▶ Remove the charging plug of the Charger from the charging port of the Range Extender after the charging process is complete.
- ▶ Close the cover on the charging port when charging is complete.
- ▶ Disconnect the Charger from the power supply.

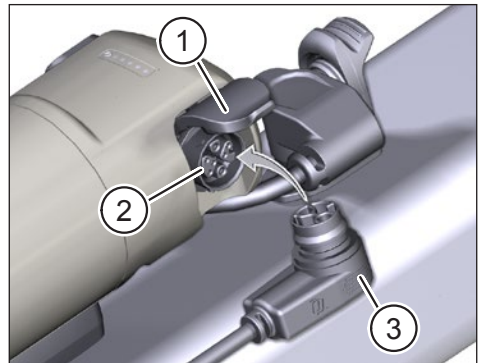

Fig. 3: Range Extender charging

3.2 Notes on the charging process

NOTE

The temperature of the Battery or Range Extender must be within the permissible charging temperature range (0 °C to 40 °C / 32 °F to 104 °F). Otherwise, the charging process will not be started.

- The drive system is deactivated in the following cases:
 - While the Battery is charging.
 - When the Range Extender is connected to the charging port of the Battery in the bike frame and is charging.
- The state of charge of the Battery and the Range Extender can be read separately on the Display.
- The state of charge of the Range Extender can also be read from the 5 LEDs located on the side of the Range Extender.

3.3 LED-states on the Charger

LED-state	Description
Off	Charger is not connected to the power supply
Red blinking	Standby (no Battery connected)
Green blinking	charging
Green permanent light	Charging process completed
Red permanent light	Error (overvoltage, undervoltage, short-circuit at output, overcurrent, overtemperature, wrong polarity)

Tab. 2: LED-states on the Charger

4 TRANSPORT AND STORAGE

- Store the Charger in a dry place, protected from direct sunlight.
- Do not drop the Charger to avoid damaging it.

5 USER MAINTENANCE

5.1 Maintenance and Service

All service, repair or maintenance work performed by a TQ authorized bicycle dealer. Your bicycle dealer can also help you with questions about bicycle use, service, repair or maintenance.

5.2 Cleaning

- ▶ Disconnect the Charger from the power supply and, if necessary from the charging port.
- ▶ Only clean the Charger with a damp cloth.
- ▶ Make sure the Charger is completely dry before reusing it.

6 Environmentally friendly disposal

The components of the drive system and the batteries must not be disposed of in the residual waste garbage can.

- Dispose of metal and plastic components in accordance with country-specific regulations.
- Dispose of electrical components in accordance with country-specific regulations. In EU countries, for example, observe the national implementations of the Waste Electrical and Electronic Equipment Directive 2012/19/EU (WEEE).
- Dispose of batteries and rechargeable batteries in accordance with the country-specific regulations. In EU countries, for example, observe the national implementations of the Waste Battery Directive 2006/66/EC in conjunction with Directives 2008/68/EC and (EU) 2020/1833.
- Observe additionally the regulations and laws of your country for disposal.

In addition you can return components of the drive system that are no longer required to a bicycle dealer authorized by TQ.



NOTE

For more information and TQ product manuals in various language, please visit www.tq-ebike.com/en/support/manuals or scan this QR-Code.



We have checked the contents of this publication for conformity with the product described. However, deviations cannot be ruled out so that we cannot accept any liability for complete conformity and correctness.

The information in this publication is reviewed regularly and any necessary corrections are included in subsequent editions.

All trademarks mentioned in this manual are the property of their respective owners.

Copyright © TQ-Systems GmbH